

Tutorial on Memory-Centric Computing: Processing-Near-Memory

Dr. Mohammad Sadr
Prof. Onur Mutlu

ISCA 2024
29 June 2024

Agenda

- Introduction to Memory-Centric Computing Systems
- Invited Talk by Prof. Minsoo Rhu:
“*Memory-Centric Computing Systems – For AI and Beyond*”
- Coffee Break
- **Real-World Processing-Near-Memory Systems**
- Processing-Using-Memory Architectures for Bulk Bitwise Op.
- Invited Talk by Prof. Saugata Ghose:
“*RACER and ReRAM PUM*”
- PIM Programming & Infrastructure for PIM Research
- Closing Remarks

Processing in Memory: Two Approaches

1. Processing near Memory
2. Processing using Memory

When to Employ PNM

Mobile consumer workloads

(GoogleWL²)

Graph processing

(Tesseract¹)

Neural networks

(GoogleWL²)

Databases

(Polynesia⁵)

Processing-
near-Memory

Time series analysis

(NATSA⁶)

DNA
sequence mapping
(GenASM³; GRIM-Filter⁴)

...

[1] Ahn+, "A Scalable Processing-in-Memory Accelerator for Parallel Graph Processing," ISCA, 2015

[2] Boroumand+, "Google Workloads for Consumer Devices: Mitigating Data Movement Bottlenecks," ASPLOS, 2018

[3] Cali+, "GenASM: A High-Performance, Low-Power Approximate String Matching Acceleration Framework for Genome Sequence Analysis," MICRO, 2020

[4] Kim+, "GRIM-Filter: Fast Seed Location Filtering in DNA Read Mapping Using Processing-in-Memory Technologies," BMC Genomics, 2018

[5] Boroumand+, "Polynesia: Enabling High-Performance and Energy-Efficient Hybrid Transactional/Analytical Databases with Hardware/Software Co-Design," ICDE, 2022

[6] Fernandez+, "NATSA: A Near-Data Processing Accelerator for Time Series Analysis," ICCD, 2020

Accelerating In-Memory Graph Processing

- Large graphs are everywhere (circa 2015)



36 Million
Wikipedia Pages



1.4 Billion
Facebook Users



300 Million
Twitter Users



30 Billion
Instagram Photos

- Scalable large-scale graph processing is challenging

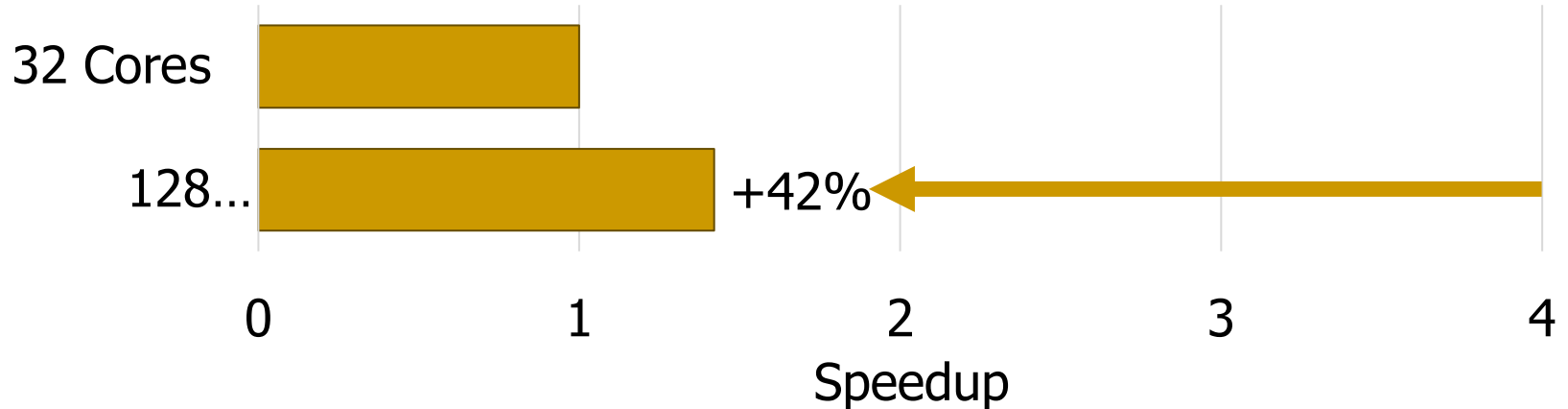

Key Bottlenecks in Graph Processing

```
for (v: graph.vertices) {  
  for (w: v.successors) {  
    w.next_rank += weight * v.rank;  
  }  
}
```

1. Frequent random memory accesses

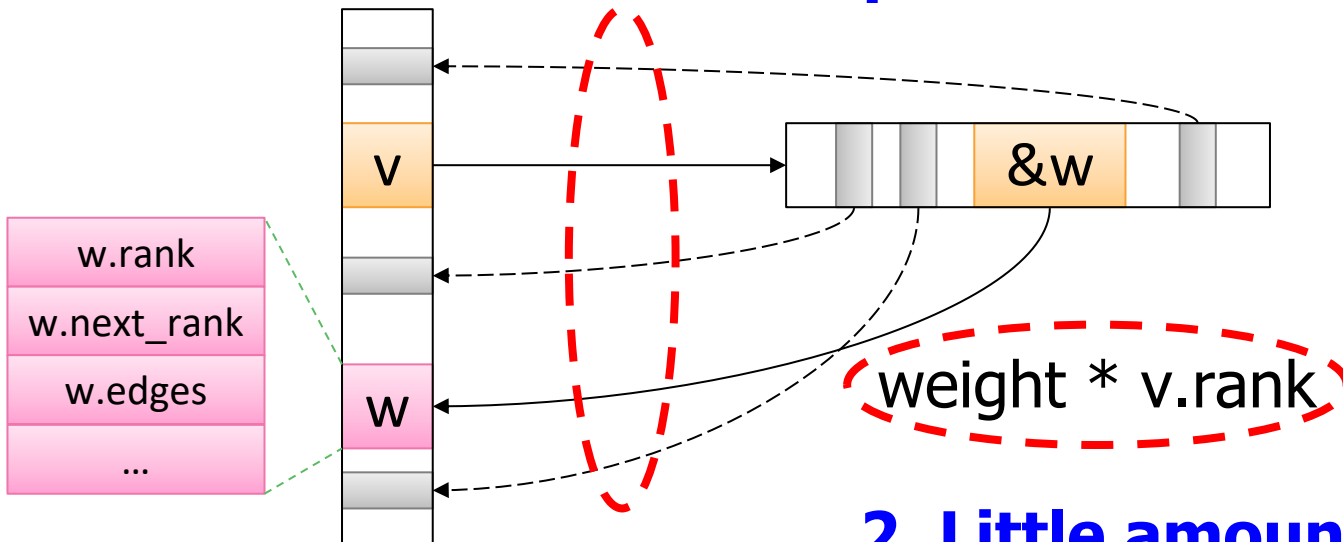

2. Little amount of computation

Opportunity: 3D-Stacked Logic+Memory



Hybrid Memory Cube
C O N S O R T I U M

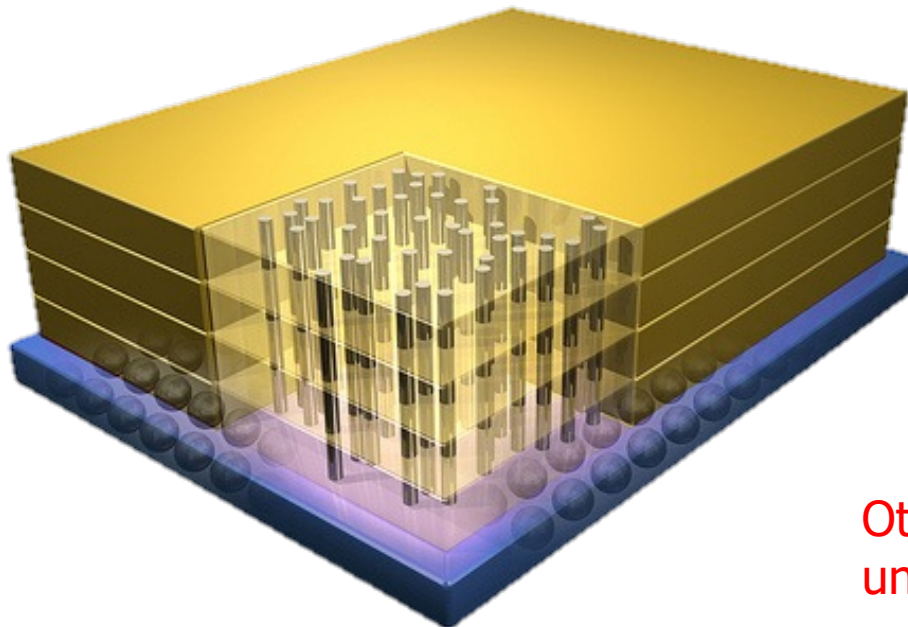

Memory

Logic

Other "True 3D" technologies
under development

Tesseract System for Graph Processing

Interconnected set of 3D-stacked memory+logic chips with simple cores

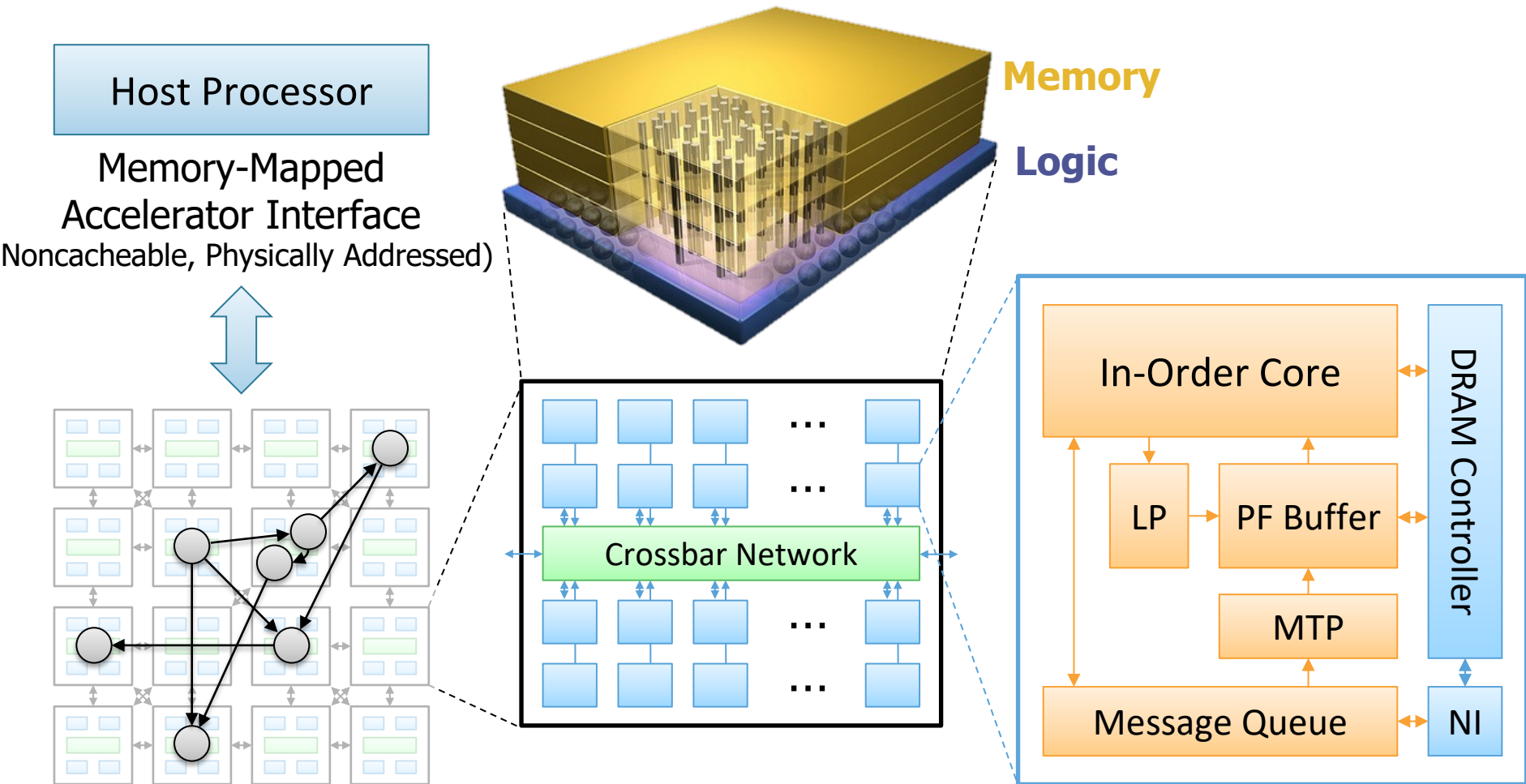

Tesseract System for Graph Processing

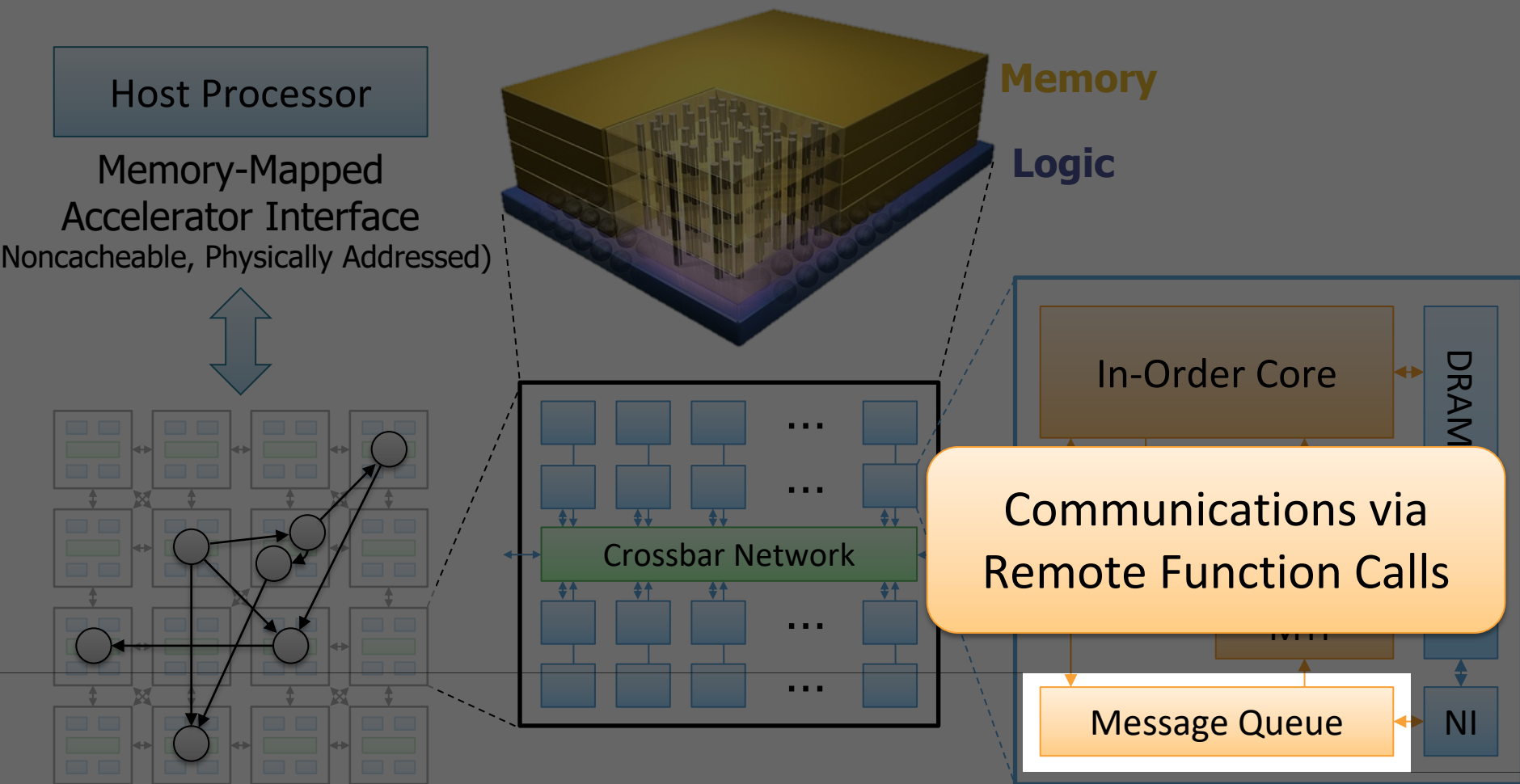

Tesseract System for Graph Processing

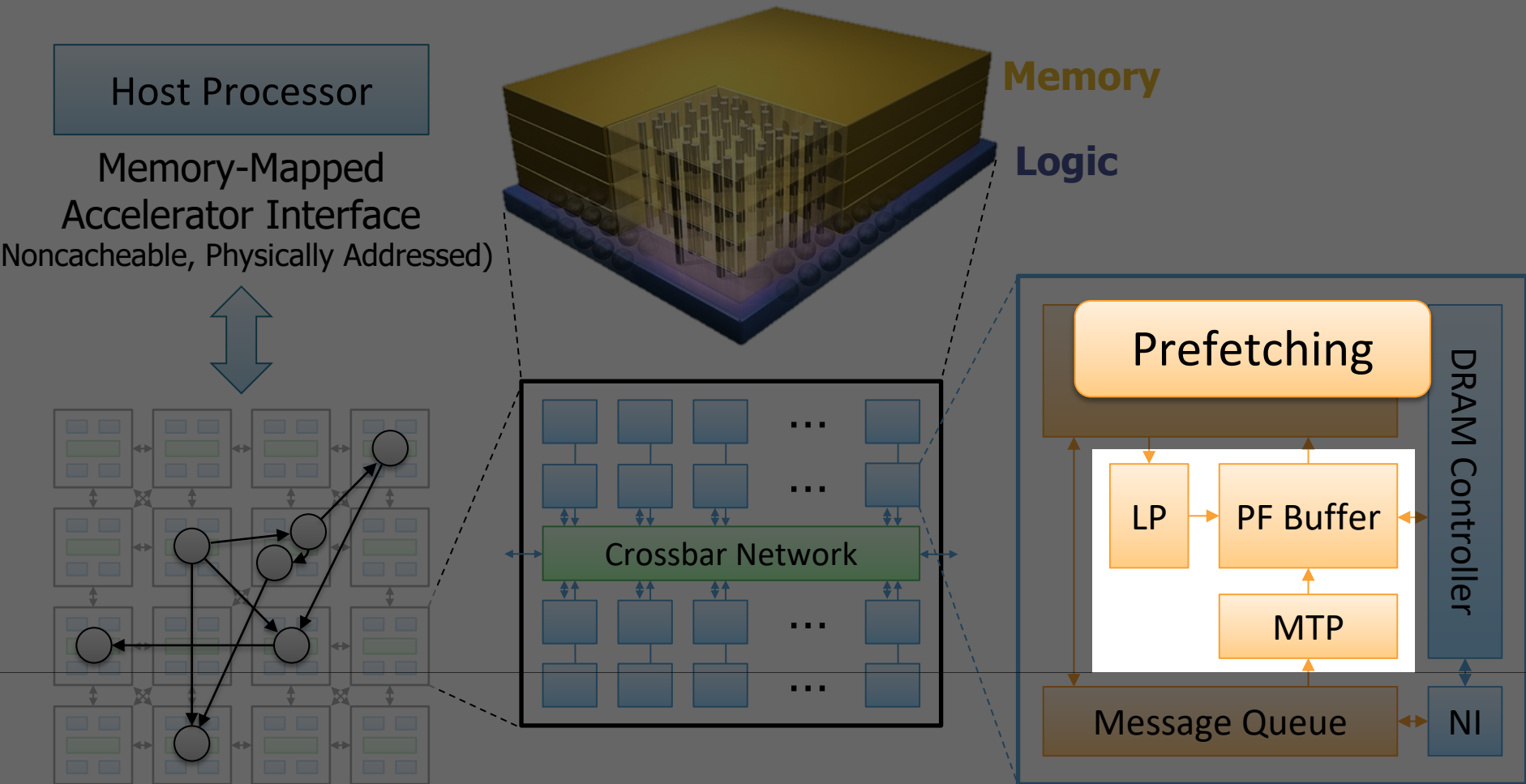

Evaluated Systems

DDR3-OoO

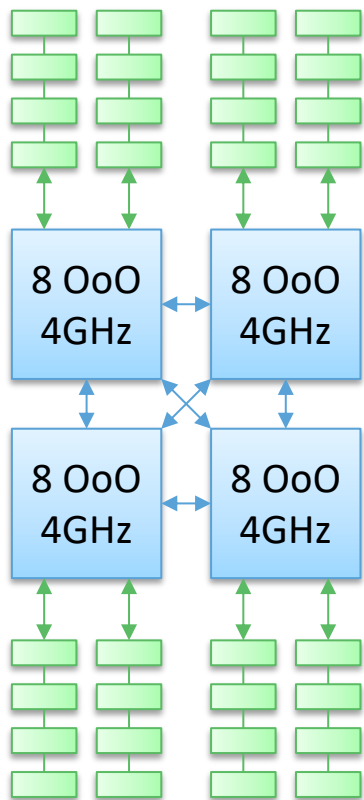

102.4GB/s

HMC-OoO

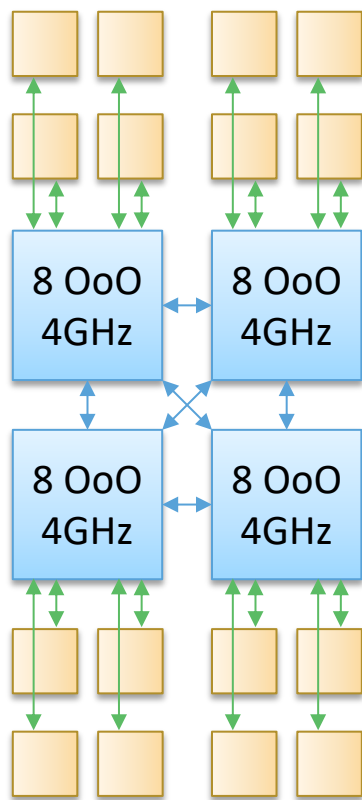

640GB/s

HMC-MC

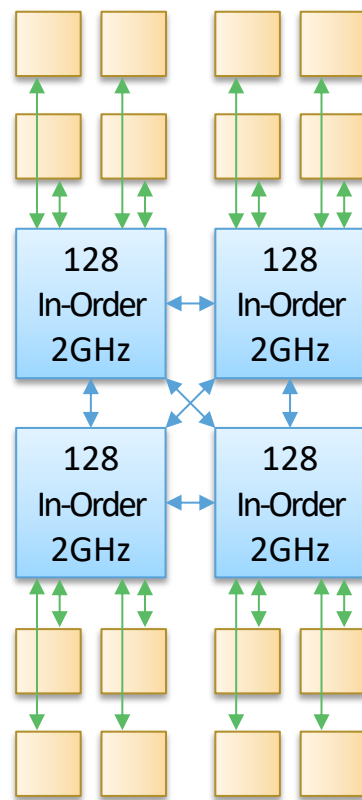

640GB/s

Tesseract

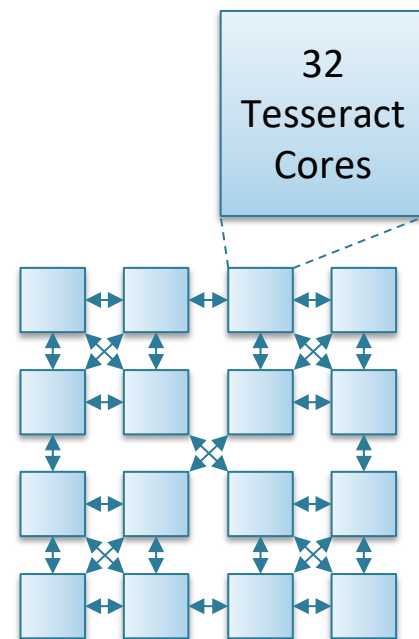

8TB/s

Tesseract Graph Processing Performance

>13X Performance Improvement

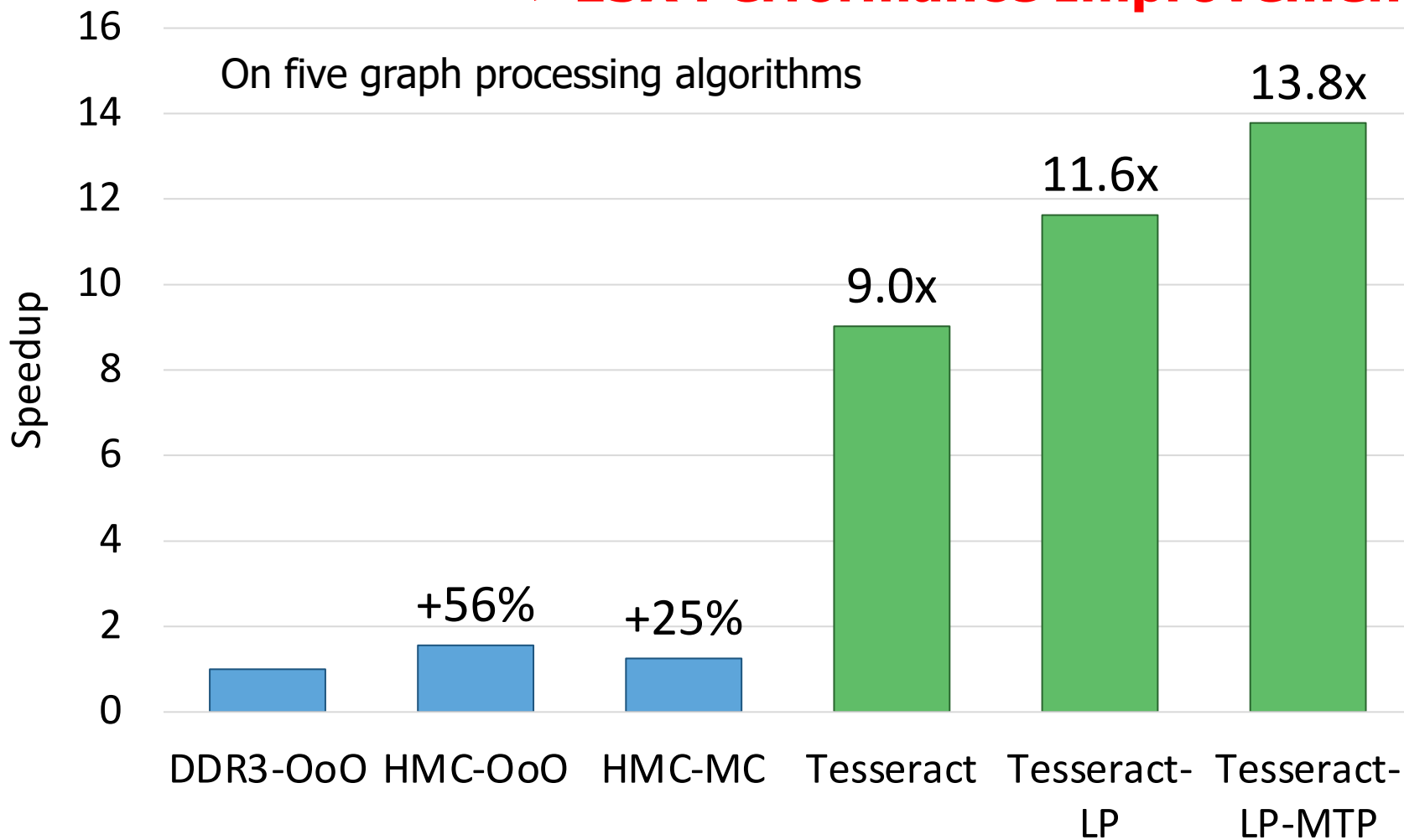

Tesseract Graph Processing System Energy

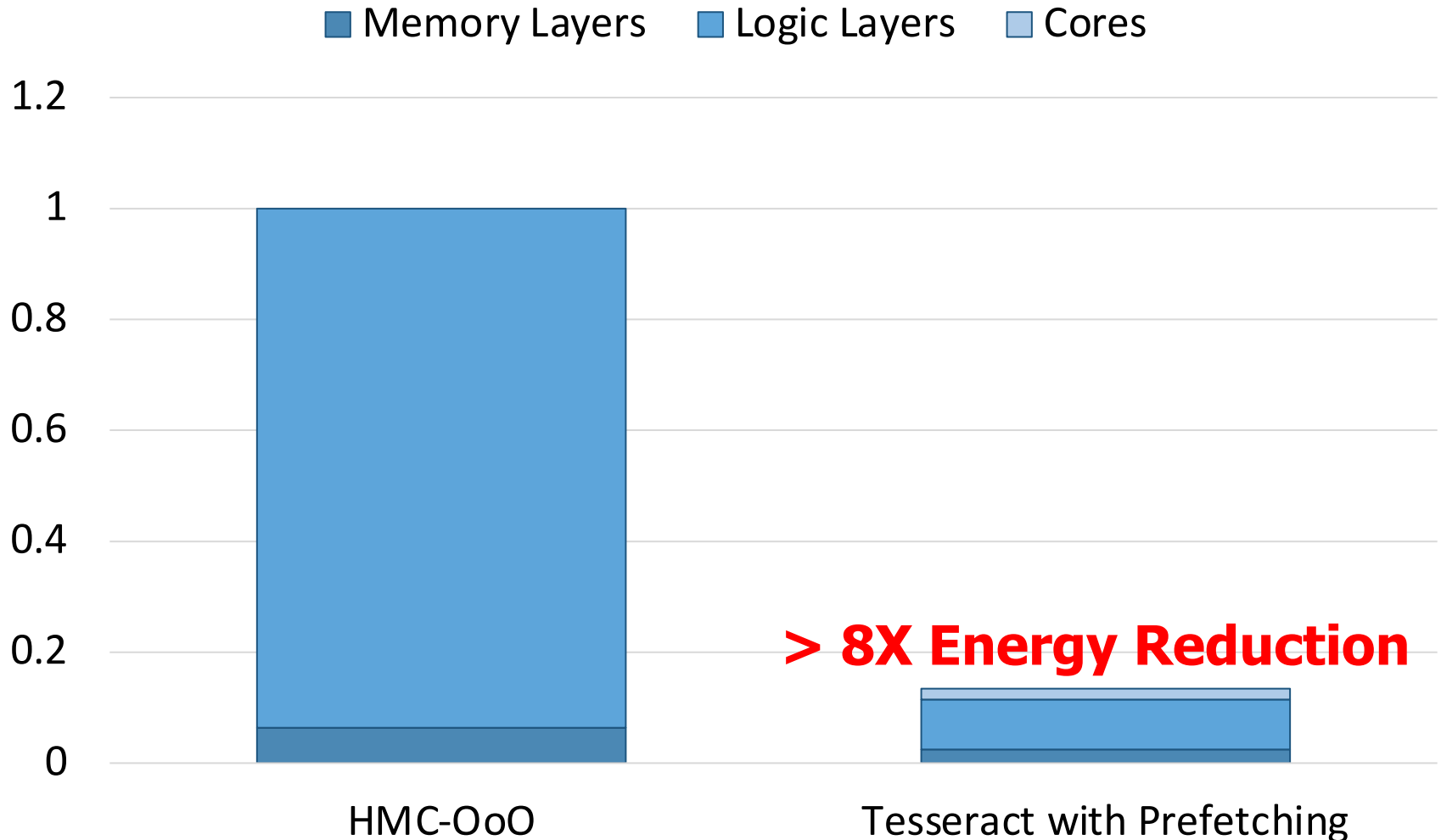

More on Tesseract

- Junwhan Ahn, Sungpack Hong, Sungjoo Yoo, Onur Mutlu, and Kiyoung Choi,
"A Scalable Processing-in-Memory Accelerator for Parallel Graph Processing"
Proceedings of the 42nd International Symposium on Computer Architecture (ISCA), Portland, OR, June 2015.
[\[Slides \(pptx\) \(pdf\)\]](#) [\[Lightning Session Slides \(pptx\) \(pdf\)\]](#)
Top Picks Honorable Mention by IEEE Micro.
Selected to the ISCA-50 25-Year Retrospective Issue covering 1996-2020 in 2023
(Retrospective (pdf) Full Issue).

A Scalable Processing-in-Memory Accelerator for Parallel Graph Processing

Junwhan Ahn Sungpack Hong[§] Sungjoo Yoo Onur Mutlu[†] Kiyoung Choi
junwhan@snu.ac.kr, sungpack.hong@oracle.com, sungjoo.yoo@gmail.com, onur@cmu.edu, kchoi@snu.ac.kr

Seoul National University

[§]Oracle Labs

[†]Carnegie Mellon University

In-Storage Genomic Data Filtering [ASPLOS 2022]

- Nika Mansouri Ghiasi, Jisung Park, Harun Mustafa, Jeremie Kim, Ataberk Olgun, Arvid Gollwitzer, Damla Senol Cali, Can Firtina, Haiyu Mao, Nour Almadhoun Alserr, Rachata Ausavarungnirun, Nandita Vijaykumar, Mohammed Alser, and Onur Mutlu, **["GenStore: A High-Performance and Energy-Efficient In-Storage Computing System for Genome Sequence Analysis"](#)**
Proceedings of the 27th International Conference on Architectural Support for Programming Languages and Operating Systems (ASPLOS), Virtual, February-March 2022.
[[Lightning Talk Slides \(pptx\)](#)] [[pdf](#)]
[[Lightning Talk Video](#) (90 seconds)] [[Talk Video](#) (17 minutes)]

GenStore: A High-Performance In-Storage Processing System for Genome Sequence Analysis

Nika Mansouri Ghiasi¹ Jisung Park¹ Harun Mustafa¹ Jeremie Kim¹ Ataberk Olgun¹
Arvid Gollwitzer¹ Damla Senol Cali² Can Firtina¹ Haiyu Mao¹ Nour Almadhoun Alserr¹
Rachata Ausavarungnirun³ Nandita Vijaykumar⁴ Mohammed Alser¹ Onur Mutlu¹

¹ETH Zürich ²Bionano Genomics ³KMUTNB ⁴University of Toronto

Genome Sequence Analysis

Data Movement from Storage



Storage
System

Main
Memory

Cache

Alignment
Computation
Unit
(CPU or
Accelerator)



Computation overhead



Data movement overhead

Compute-Centric Accelerators

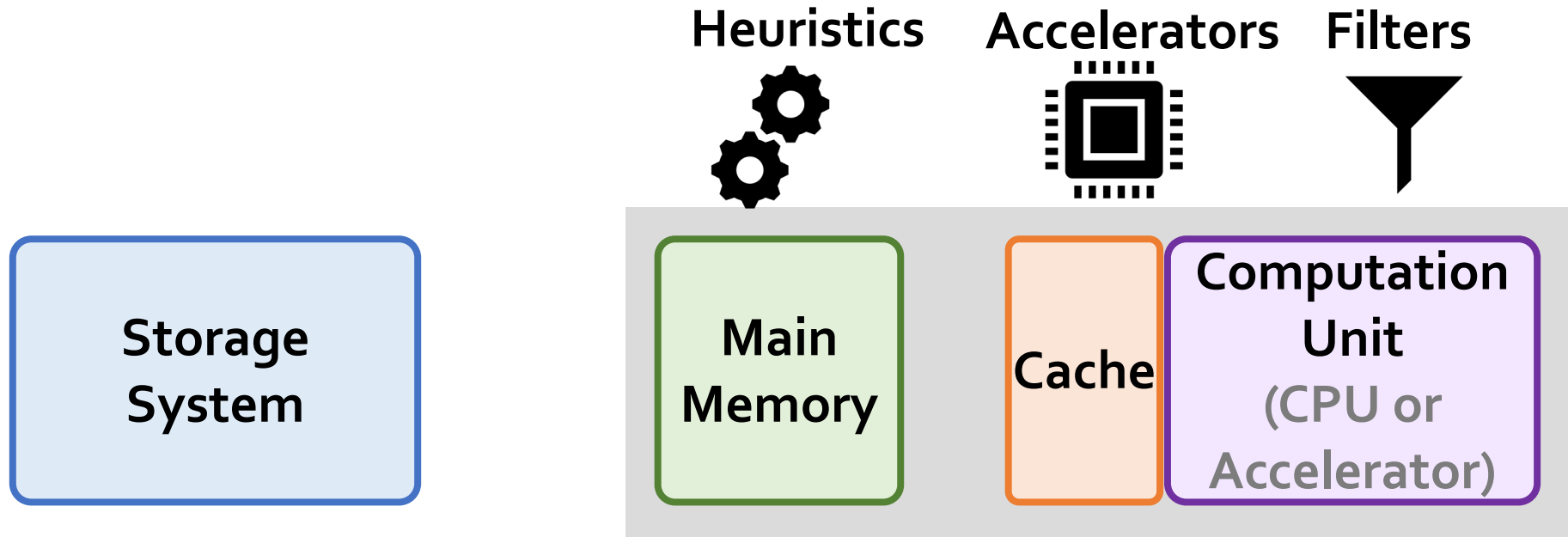

Computation overhead



Data movement overhead

Key Idea: In-Storage Filtering



Filter reads that do not require alignment inside the storage system

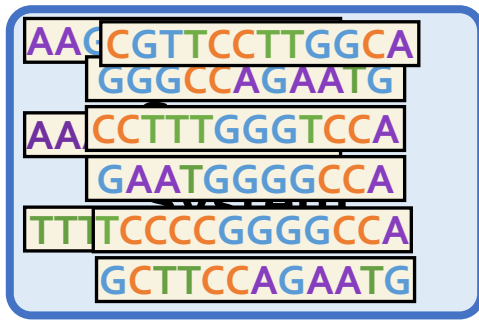

Filtered Reads

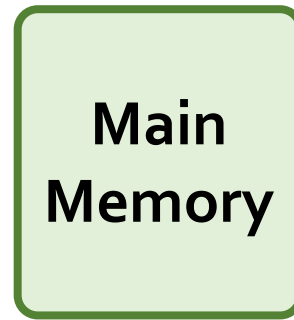

**Main
Memory**



Cache

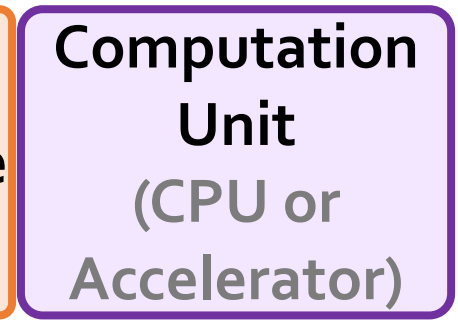

**Computation
Unit
(CPU or
Accelerator)**

Exactly-matching reads

Do not need expensive approximate string matching during alignment

Non-matching reads

Do not have potential matching locations and can skip alignment

GenStore



Filter reads that do not require alignment inside the storage system

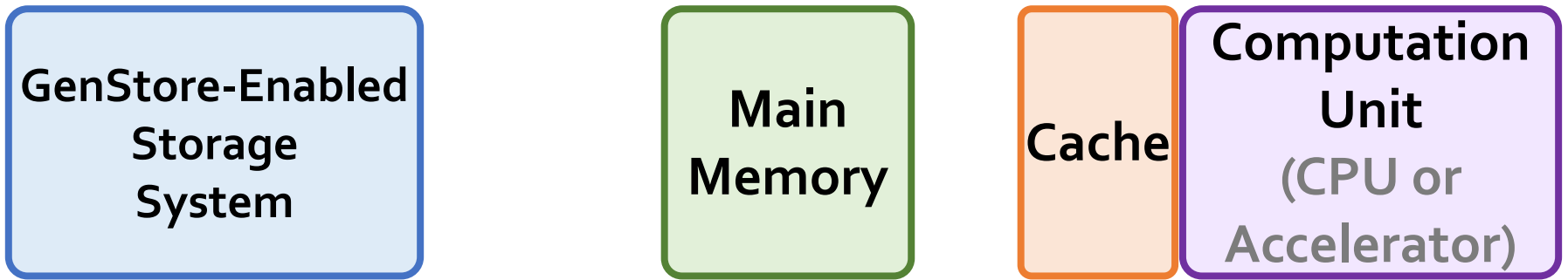

Computation overhead

Data movement overhead

GenStore provides significant speedup (1.4x - 33.6x) and energy reduction (3.9x - 29.2x) at low cost

In-Storage Genomic Data Filtering [ASPLOS 2022]

- Nika Mansouri Ghiasi, Jisung Park, Harun Mustafa, Jeremie Kim, Ataberk Olgun, Arvid Gollwitzer, Damla Senol Cali, Can Firtina, Haiyu Mao, Nour Almadhoun Alserr, Rachata Ausavarungnirun, Nandita Vijaykumar, Mohammed Alser, and Onur Mutlu, **"GenStore: A High-Performance and Energy-Efficient In-Storage Computing System for Genome Sequence Analysis"**
Proceedings of the 27th International Conference on Architectural Support for Programming Languages and Operating Systems (ASPLOS), Virtual, February-March 2022.
[[Lightning Talk Slides \(pptx\)](#)] ([pdf](#))
[[Lightning Talk Video](#) (90 seconds)]

GenStore: A High-Performance In-Storage Processing System for Genome Sequence Analysis

Nika Mansouri Ghiasi¹ Jisung Park¹ Harun Mustafa¹ Jeremie Kim¹ Ataberk Olgun¹
Arvid Gollwitzer¹ Damla Senol Cali² Can Firtina¹ Haiyu Mao¹ Nour Almadhoun Alserr¹
Rachata Ausavarungnirun³ Nandita Vijaykumar⁴ Mohammed Alser¹ Onur Mutlu¹

¹ETH Zürich ²Bionano Genomics ³KMUTNB ⁴University of Toronto

Google Workloads for Consumer Devices: Mitigating Data Movement Bottlenecks

Amirali Boroumand

Saugata Ghose, Youngsok Kim, Rachata Ausavarungnirun,
Eric Shiu, Rahul Thakur, Daehyun Kim, Aki Kuusela,
Allan Knies, Parthasarathy Ranganathan, Onur Mutlu

SAFARI

Carnegie Mellon

Google



SEOUL
NATIONAL
UNIVERSITY

ETH zürich

Consumer Devices



Consumer devices are everywhere!

**Energy consumption is
a first-class concern in consumer devices**



Popular Consumer Workloads



Chrome

Google's web browser



TensorFlow Mobile

Google's machine learning framework

VP9



Video Playback

Google's **video codec**

VP9



Video Capture

Google's **video codec**

Energy Cost of Data Movement

1st key observation: **62.7%** of the total system energy is spent on **data movement**

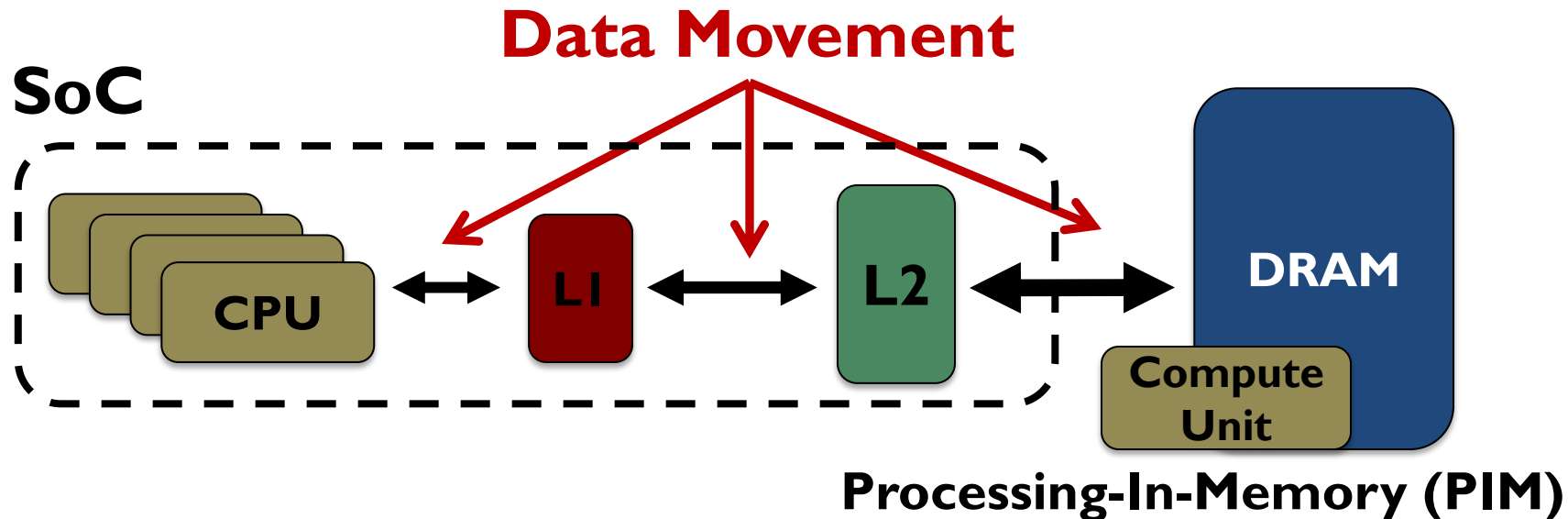

Potential solution: move computation **close to data**

Challenge: limited area and energy budget

Using PIM to Reduce Data Movement

2nd key observation: a significant fraction of the **data movement** often comes from **simple functions**

We can design lightweight logic to implement these simple functions in **memory**

Small embedded
low-power core



Small fixed-function
accelerators



Offloading to PIM logic reduces energy and improves performance, on average, by **2.3X** and **2.2X**

Workload Analysis



Chrome

Google's web browser



TensorFlow Mobile

Google's machine learning framework

VP9



Video Playback

Google's **video codec**

VP9



Video Capture

Google's **video codec**

TensorFlow Mobile

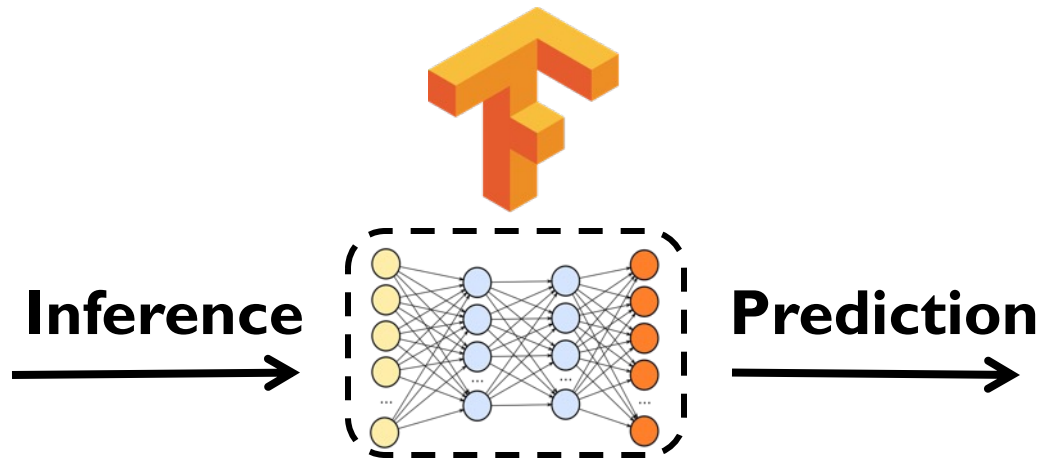

57.3% of the inference energy is spent on data movement



54.4% of the data movement energy comes from packing/unpacking and quantization

Normalized Energy

■ CPU-Only ■ PIM-Core ■ PIM-Acc

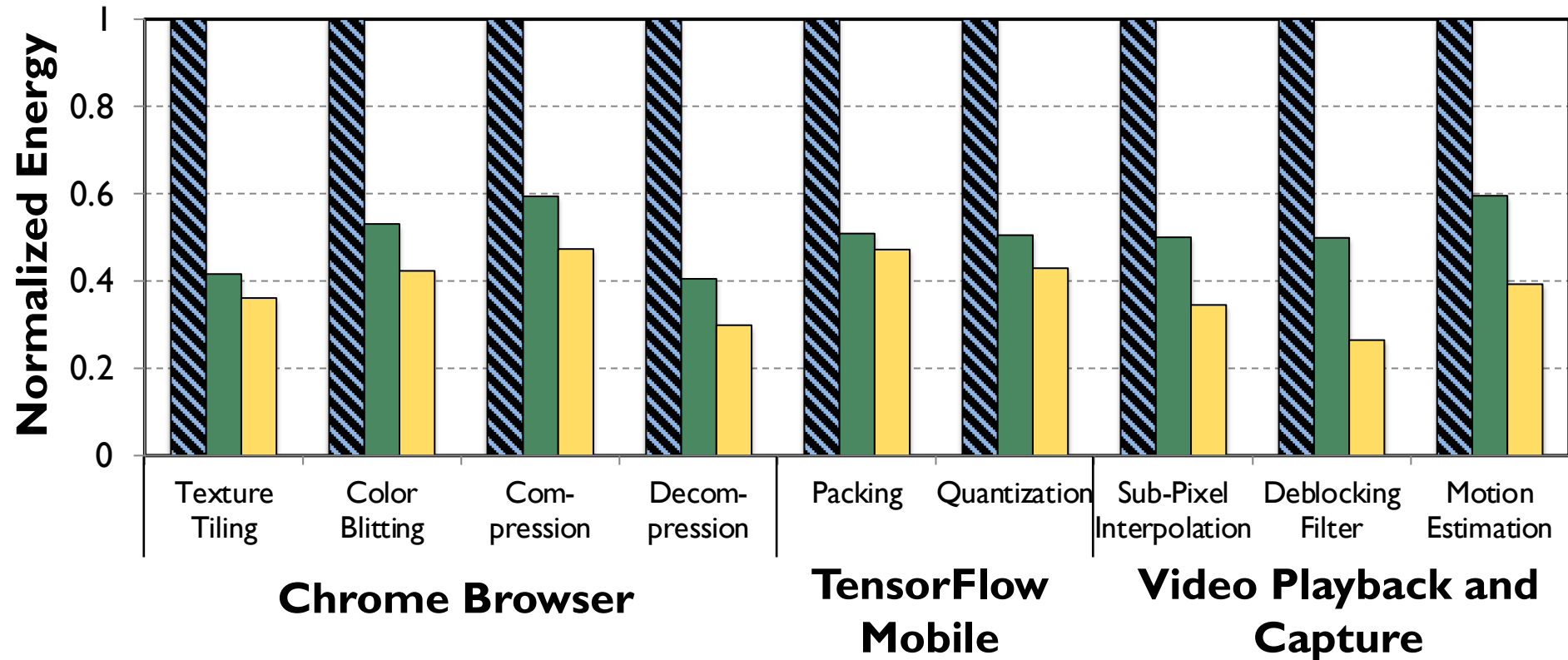

PIM core and PIM accelerator reduce energy consumption on average by 49.1% and 55.4%

Normalized Runtime

▨ CPU-Only █ PIM-Core █ PIM-Acc

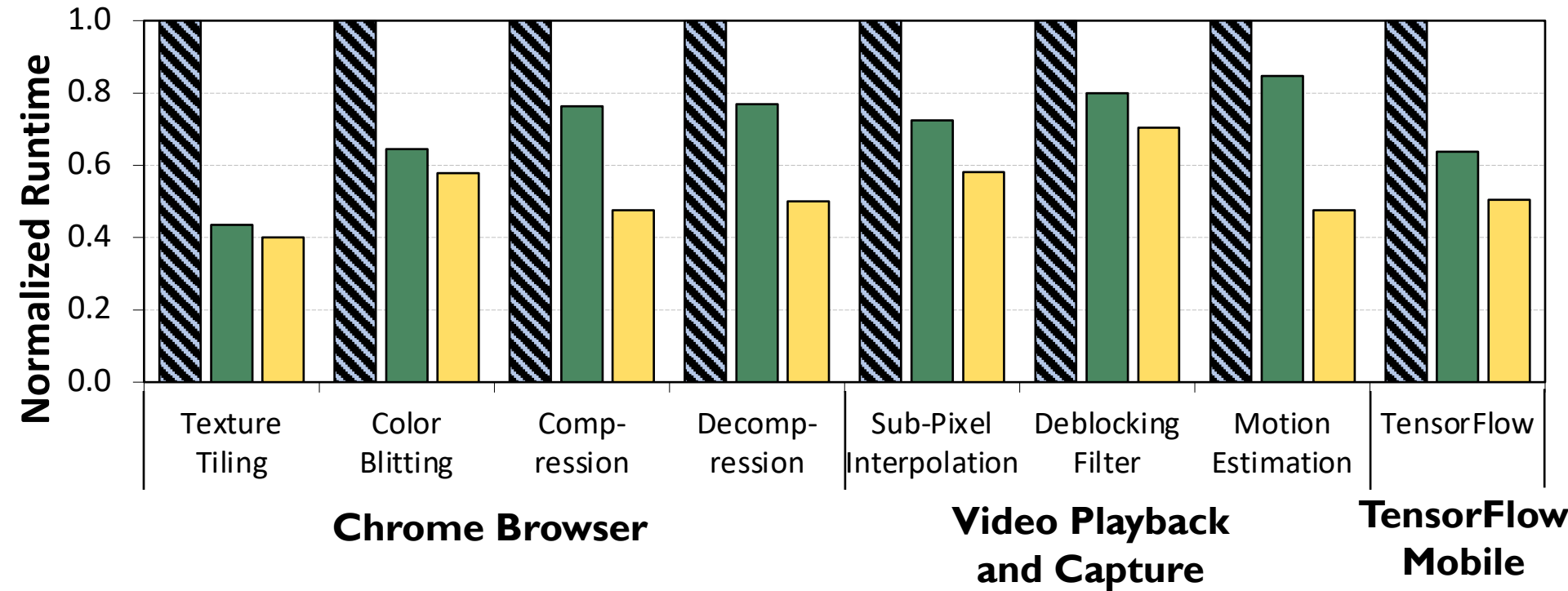

Offloading these kernels to **PIM core** and **PIM accelerator** reduces **program runtime** on average by **44.6%** and **54.2%**

More on PIM for Mobile Devices

- Amirali Boroumand, Saugata Ghose, Youngsok Kim, Rachata Ausavarungnirun, Eric Shiu, Rahul Thakur, Daehyun Kim, Aki Kuusela, Allan Knies, Parthasarathy Ranganathan, and Onur Mutlu,

"Google Workloads for Consumer Devices: Mitigating Data Movement Bottlenecks"

Proceedings of the 23rd International Conference on Architectural Support for Programming Languages and Operating Systems (ASPLOS), Williamsburg, VA, USA, March 2018.

[[Slides \(pptx\) \(pdf\)](#)] [[Lightning Session Slides \(pptx\) \(pdf\)](#)] [[Poster \(pptx\) \(pdf\)](#)]

[[Lightning Talk Video](#) (2 minutes)]

[[Full Talk Video](#) (21 minutes)]

Google Workloads for Consumer Devices: Mitigating Data Movement Bottlenecks

Amirali Boroumand¹

Saugata Ghose¹

Youngsok Kim²

Rachata Ausavarungnirun¹

Eric Shiu³

Rahul Thakur³

Daehyun Kim^{4,3}

Aki Kuusela³

Allan Knies³

Parthasarathy Ranganathan³

Onur Mutlu^{5,1}

Accelerating GPU Execution with PIM (I)

- Kevin Hsieh, Eiman Ebrahimi, Gwangsun Kim, Niladrish Chatterjee, Mike O'Connor, Nandita Vijaykumar, Onur Mutlu, and Stephen W. Keckler, **"Transparent Offloading and Mapping (TOM): Enabling Programmer-Transparent Near-Data Processing in GPU Systems"**

Proceedings of the 43rd International Symposium on Computer Architecture (ISCA), Seoul, South Korea, June 2016.

[[Slides \(pptx\)](#) ([pdf](#))]

[[Lightning Session Slides \(pptx\)](#) ([pdf](#))]

Transparent Offloading and Mapping (TOM):

Enabling Programmer-Transparent Near-Data Processing in GPU Systems

Kevin Hsieh[‡] Eiman Ebrahimi[†] Gwangsun Kim* Niladrish Chatterjee[†] Mike O'Connor[†]
Nandita Vijaykumar[‡] Onur Mutlu^{§‡} Stephen W. Keckler[†]

[‡]Carnegie Mellon University [†]NVIDIA ^{*}KAIST [§]ETH Zürich

Accelerating GPU Execution with PIM (II)

- Ashutosh Pattnaik, Xulong Tang, Adwait Jog, Onur Kayiran, Asit K. Mishra, Mahmut T. Kandemir, Onur Mutlu, and Chita R. Das, **"Scheduling Techniques for GPU Architectures with Processing-In-Memory Capabilities"**
Proceedings of the 25th International Conference on Parallel Architectures and Compilation Techniques (PACT), Haifa, Israel, September 2016.

Scheduling Techniques for GPU Architectures with Processing-In-Memory Capabilities

Ashutosh Pattnaik¹ Xulong Tang¹ Adwait Jog² Onur Kayiran³
Asit K. Mishra⁴ Mahmut T. Kandemir¹ Onur Mutlu^{5,6} Chita R. Das¹

¹Pennsylvania State University ²College of William and Mary
³Advanced Micro Devices, Inc. ⁴Intel Labs ⁵ETH Zürich ⁶Carnegie Mellon University

Accelerating Linked Data Structures

- Kevin Hsieh, Samira Khan, Nandita Vijaykumar, Kevin K. Chang, Amirali Boroumand, Saugata Ghose, and Onur Mutlu,
["Accelerating Pointer Chasing in 3D-Stacked Memory: Challenges, Mechanisms, Evaluation"](#)
Proceedings of the 34th IEEE International Conference on Computer Design (ICCD), Phoenix, AZ, USA, October 2016.

Accelerating Pointer Chasing in 3D-Stacked Memory: Challenges, Mechanisms, Evaluation

Kevin Hsieh[†] Samira Khan[‡] Nandita Vijaykumar[†]
Kevin K. Chang[†] Amirali Boroumand[†] Saugata Ghose[†] Onur Mutlu^{§†}
[†]*Carnegie Mellon University* [‡]*University of Virginia* [§]*ETH Zürich*

Accelerating Dependent Cache Misses

- Milad Hashemi, Khubaib, Eiman Ebrahimi, Onur Mutlu, and Yale N. Patt, **"Accelerating Dependent Cache Misses with an Enhanced Memory Controller"**

Proceedings of the 43rd International Symposium on Computer Architecture (ISCA), Seoul, South Korea, June 2016.

[[Slides \(pptx\)](#) ([pdf](#))]

[[Lightning Session Slides \(pptx\)](#) ([pdf](#))]

Accelerating Dependent Cache Misses with an Enhanced Memory Controller

Milad Hashemi*, Khubaib†, Eiman Ebrahimi‡, Onur Mutlu§, Yale N. Patt*

*The University of Texas at Austin †Apple ‡NVIDIA §ETH Zürich & Carnegie Mellon University

Accelerating Runahead Execution

- Milad Hashemi, Onur Mutlu, and Yale N. Patt,
"Continuous Runahead: Transparent Hardware Acceleration for Memory Intensive Workloads"
Proceedings of the 49th International Symposium on Microarchitecture (MICRO), Taipei, Taiwan, October 2016.
[[Slides \(pptx\) \(pdf\)](#)] [[Lightning Session Slides \(pdf\)](#)] [[Poster \(pptx\) \(pdf\)](#)]
Best paper session.

Continuous Runahead: Transparent Hardware Acceleration for Memory Intensive Workloads

Milad Hashemi*, Onur Mutlu[§], Yale N. Patt*

**The University of Texas at Austin* [§]*ETH Zürich*

Accelerating Climate Modeling

- Gagandeep Singh, Dionysios Diamantopoulos, Christoph Hagleitner, Juan Gómez-Luna, Sander Stuijk, Onur Mutlu, and Henk Corporaal,

"NERO: A Near High-Bandwidth Memory Stencil Accelerator for Weather Prediction Modeling"

Proceedings of the 30th International Conference on Field-Programmable Logic and Applications (FPL), Gothenburg, Sweden, September 2020.

[[Slides \(pptx\)](#) ([pdf](#))]

[[Lightning Talk Slides \(pptx\)](#) ([pdf](#))]

[[Talk Video](#) (23 minutes)]

Nominated for the Stamatis Vassiliadis Memorial Award.

NERO: A Near High-Bandwidth Memory Stencil Accelerator for Weather Prediction Modeling

Gagandeep Singh^{a,b,c}

Dionysios Diamantopoulos^c

Christoph Hagleitner^c

Juan Gómez-Luna^b

Sander Stuijk^a

Onur Mutlu^b

Henk Corporaal^a

^aEindhoven University of Technology

^bETH Zürich

^cIBM Research Europe, Zurich

Accelerating Approximate String Matching

- Damla Senol Cali, Gurpreet S. Kalsi, Zülal Bingöl, Can Firtina, Lavanya Subramanian, Jeremie S. Kim, Rachata Ausavarungnirun, Mohammed Alser, Juan Gomez-Luna, Amirali Boroumand, Anant Nori, Allison Scibisz, Sreenivas Subramoney, Can Alkan, Saugata Ghose, and Onur Mutlu, "[GenASM: A High-Performance, Low-Power Approximate String Matching Acceleration Framework for Genome Sequence Analysis](#)"
Proceedings of the [53rd International Symposium on Microarchitecture \(MICRO\)](#), Virtual, October 2020.
[[Lighting Talk Video](#) (1.5 minutes)]
[[Lightning Talk Slides \(pptx\)](#) ([pdf](#))]
[[Talk Video](#) (18 minutes)]
[[Slides \(pptx\)](#) ([pdf](#))]

GenASM: A High-Performance, Low-Power Approximate String Matching Acceleration Framework for Genome Sequence Analysis

Damla Senol Cali[†][✕] Gurpreet S. Kalsi[✕] Zülal Bingöl[∇] Can Firtina[◇] Lavanya Subramanian[‡] Jeremie S. Kim[◇][†]
Rachata Ausavarungnirun[○] Mohammed Alser[◇] Juan Gomez-Luna[◇] Amirali Boroumand[†] Anant Nori[✕]
Allison Scibisz[†] Sreenivas Subramoney[✕] Can Alkan[∇] Saugata Ghose^{*†} Onur Mutlu[◇][†][∇]
[†]Carnegie Mellon University [✕]Processor Architecture Research Lab, Intel Labs [∇]Bilkent University [◇]ETH Zürich
[‡]Facebook [○]King Mongkut's University of Technology North Bangkok ^{*}University of Illinois at Urbana-Champaign

Accelerating Sequence-to-Graph Mapping

- Damla Senol Cali, Konstantinos Kanellopoulos, Joel Lindegger, Zulal Bingol, Gurpreet S. Kalsi, Ziyi Zuo, Can Firtina, Meryem Banu Cavlak, Jeremie Kim, Nika MansouriGhiasi, Gagandeep Singh, Juan Gomez-Luna, Nour Almadhoun Alserr, Mohammed Alser, Sreenivas Subramoney, Can Alkan, Saugata Ghose, and Onur Mutlu,
"SeGraM: A Universal Hardware Accelerator for Genomic Sequence-to-Graph and Sequence-to-Sequence Mapping"
Proceedings of the 49th International Symposium on Computer Architecture (ISCA), New York, June 2022.
[[arXiv version](#)]

SeGraM: A Universal Hardware Accelerator for Genomic Sequence-to-Graph and Sequence-to-Sequence Mapping

Damla Senol Cali¹ Konstantinos Kanellopoulos² Joël Lindegger² Zülal Bingöl³
Gurpreet S. Kalsi⁴ Ziyi Zuo⁵ Can Firtina² Meryem Banu Cavlak² Jeremie Kim²
Nika Mansouri Ghiasi² Gagandeep Singh² Juan Gómez-Luna² Nour Almadhoun Alserr²
Mohammed Alser² Sreenivas Subramoney⁴ Can Alkan³ Saugata Ghose⁶ Onur Mutlu²

¹Bionano Genomics ²ETH Zürich ³Bilkent University ⁴Intel Labs
⁵Carnegie Mellon University ⁶University of Illinois Urbana-Champaign

Accelerating Basecalling + Read Mapping

- Haiyu Mao, Mohammed Alser, Mohammad Sadrosadati, Can Firtina, Akanksha Baranwal, Damla Senol Cali, Aditya Manglik, Nour Almadhoun Alserr, and Onur Mutlu, **["GenPIP: In-Memory Acceleration of Genome Analysis via Tight Integration of Basecalling and Read Mapping"](#)**
Proceedings of the 55th International Symposium on Microarchitecture (MICRO), Chicago, IL, USA, October 2022.
[[Slides \(pptx\)](#)] [[pdf](#)]
[[Longer Lecture Slides \(pptx\)](#)] [[pdf](#)]
[[Lecture Video](#) (25 minutes)]
[[arXiv version](#)]

GenPIP: In-Memory Acceleration of Genome Analysis via Tight Integration of Basecalling and Read Mapping

Haiyu Mao¹ Mohammed Alser¹ Mohammad Sadrosadati¹ Can Firtina¹ Akanksha Baranwal¹
Damla Senol Cali² Aditya Manglik¹ Nour Almadhoun Alserr¹ Onur Mutlu¹
¹*ETH Zürich* ²*Bionano Genomics*

Accelerating Time Series Analysis

- Ivan Fernandez, Ricardo Quisiant, Christina Giannoula, Mohammed Alser, Juan Gómez-Luna, Eladio Gutiérrez, Oscar Plata, and Onur Mutlu, **"NATSA: A Near-Data Processing Accelerator for Time Series Analysis"**
Proceedings of the 38th IEEE International Conference on Computer Design (ICCD), Virtual, October 2020.
[[Slides \(pptx\)](#)] [[pdf](#)]
[[Talk Video](#) (10 minutes)]
[[Source Code](#)]

NATSA: A Near-Data Processing Accelerator for Time Series Analysis

Ivan Fernandez[§]

Ricardo Quisiant[§]

Christina Giannoula[†]

Mohammed Alser[‡]

Juan Gómez-Luna[‡]

Eladio Gutiérrez[§]

Oscar Plata[§]

Onur Mutlu[‡]

[§]*University of Malaga*

[†]*National Technical University of Athens*

[‡]*ETH Zürich*

Accelerating Graph Pattern Mining

- Maciej Besta, Raghavendra Kanakagiri, Grzegorz Kwasniewski, Rachata Ausavarungnirun, Jakub Beránek, Konstantinos Kanellopoulos, Kacper Janda, Zur Vonarburg-Shmaria, Lukas Gianinazzi, Ioana Stefan, Juan Gómez-Luna, Marcin Copik, Lukas Kapp-Schwoerer, Salvatore Di Girolamo, Nils Blach, Marek Konieczny, Onur Mutlu, and Torsten Hoefler,

["SISA: Set-Centric Instruction Set Architecture for Graph Mining on Processing-in-Memory Systems"](#)

Proceedings of the [54th International Symposium on Microarchitecture \(MICRO\)](#), Virtual, October 2021.

[[Slides \(pdf\)](#)]

[[Talk Video](#) (22 minutes)]

[[Lightning Talk Video](#) (1.5 minutes)]

[[Full arXiv version](#)]

SISA: Set-Centric Instruction Set Architecture for Graph Mining on Processing-in-Memory Systems

Maciej Besta¹, Raghavendra Kanakagiri², Grzegorz Kwasniewski¹, Rachata Ausavarungnirun³, Jakub Beránek⁴, Konstantinos Kanellopoulos¹, Kacper Janda⁵, Zur Vonarburg-Shmaria¹, Lukas Gianinazzi¹, Ioana Stefan¹, Juan Gómez-Luna¹, Marcin Copik¹, Lukas Kapp-Schwoerer¹, Salvatore Di Girolamo¹, Nils Blach¹, Marek Konieczny⁵, Onur Mutlu¹, Torsten Hoefler¹

¹ETH Zurich, Switzerland
Thailand

²IIT Tirupati, India

³King Mongkut's University of Technology North Bangkok,
⁴Technical University of Ostrava, Czech Republic

⁵AGH-UST, Poland

Accelerating HTAP Database Systems

- Amirali Boroumand, Saugata Ghose, Geraldo F. Oliveira, and Onur Mutlu, **"Polynesia: Enabling High-Performance and Energy-Efficient Hybrid Transactional/Analytical Databases with Hardware/Software Co-Design"** *Proceedings of the 38th International Conference on Data Engineering (ICDE)*, Virtual, May 2022.
[[arXiv version](#)]
[[Slides \(pptx\)](#) ([pdf](#))]
[[Short Talk Slides \(pptx\)](#) ([pdf](#))]

Polynesia: Enabling High-Performance and Energy-Efficient Hybrid Transactional/Analytical Databases with Hardware/Software Co-Design

Amirali Boroumand[†]
[†]*Google*

Saugata Ghose[◇]
[◇]*Univ. of Illinois Urbana-Champaign*

Geraldo F. Oliveira[‡]
[‡]*ETH Zürich*

Onur Mutlu[‡]

Accelerating Neural Network Inference

- Amirali Boroumand, Saugata Ghose, Berkin Akin, Ravi Narayanaswami, Geraldo F. Oliveira, Xiaoyu Ma, Eric Shiu, and Onur Mutlu,
"Google Neural Network Models for Edge Devices: Analyzing and Mitigating Machine Learning Inference Bottlenecks"
Proceedings of the 30th International Conference on Parallel Architectures and Compilation Techniques (PACT), Virtual, September 2021.
[[Slides \(pptx\)](#)] [[pdf](#)]
[[Talk Video](#) (14 minutes)]

Google Neural Network Models for Edge Devices: Analyzing and Mitigating Machine Learning Inference Bottlenecks

Amirali Boroumand^{†◇}

Saugata Ghose[‡]

Berkin Akin[§]

Ravi Narayanaswami[§]

Geraldo F. Oliveira^{*}

Xiaoyu Ma[§]

Eric Shiu[§]

Onur Mutlu^{*†}

[†]*Carnegie Mellon Univ.*

[◇]*Stanford Univ.*

[‡]*Univ. of Illinois Urbana-Champaign*

[§]*Google*

^{*}*ETH Zürich*

Google Neural Network Models for Edge Devices: Analyzing and Mitigating Machine Learning Inference Bottlenecks

Amirali Boroumand

Saugata Ghose

Berkin Akin

Ravi Narayanaswami

Geraldo F. Oliveira

Xiaoyu Ma

Eric Shiu

Onur Mutlu

PACT 2021

SAFARI

Carnegie Mellon



UNIVERSITY OF
ILLINOIS
URBANA-CHAMPAIGN



ETH zürich

Executive Summary

Context: We extensively analyze a state-of-the-art edge ML accelerator (Google Edge TPU) using 24 Google edge models

- Wide range of models (CNNs, LSTMs, Transducers, RCNNs)

Problem: The Edge TPU accelerator suffers from **three challenges:**

- It operates **significantly below** its peak throughput
- It operates **significantly below** its theoretical energy efficiency
- It **inefficiently** handles memory accesses

Key Insight: These shortcomings arise from **the monolithic design** of the Edge TPU accelerator

- The Edge TPU accelerator design does not account for **layer heterogeneity**

Key Mechanism: A new framework called **Mensa**

- Mensa consists of heterogeneous accelerators whose dataflow and hardware are specialized for specific families of layers

Key Results: We design a version of Mensa for Google edge ML models

- Mensa improves performance and energy by **3.0X** and **3.1X**
- Mensa reduces cost and improves area efficiency

Google Edge Neural Network Models

We analyze inference execution using 24 edge NN models

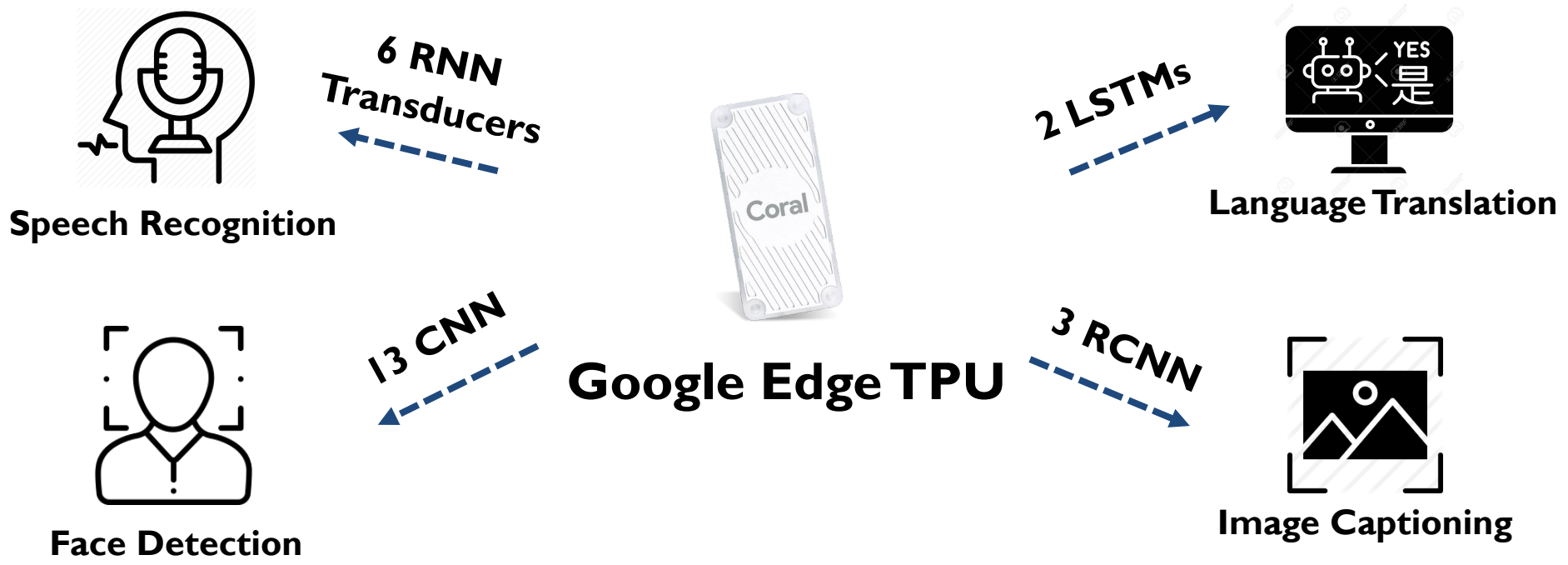

Diversity Across the Models

Insight 1: there is **significant variation** in terms of **layer characteristics** **across the models**

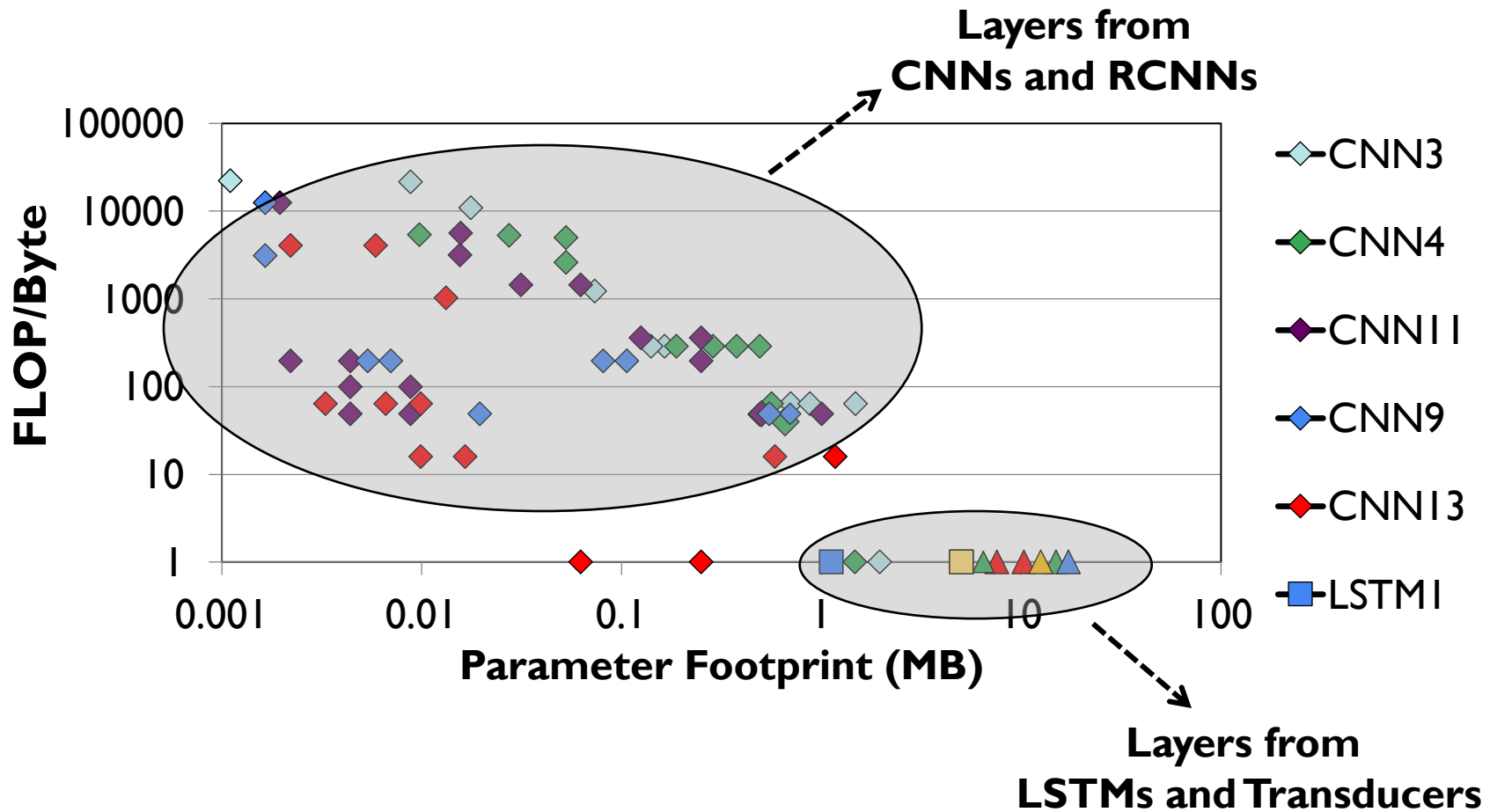

Diversity Within the Models

Insight 2: even **within** each model, layers exhibit **significant variation** in terms of layer characteristics

For example, our analysis of edge **CNN** models shows:

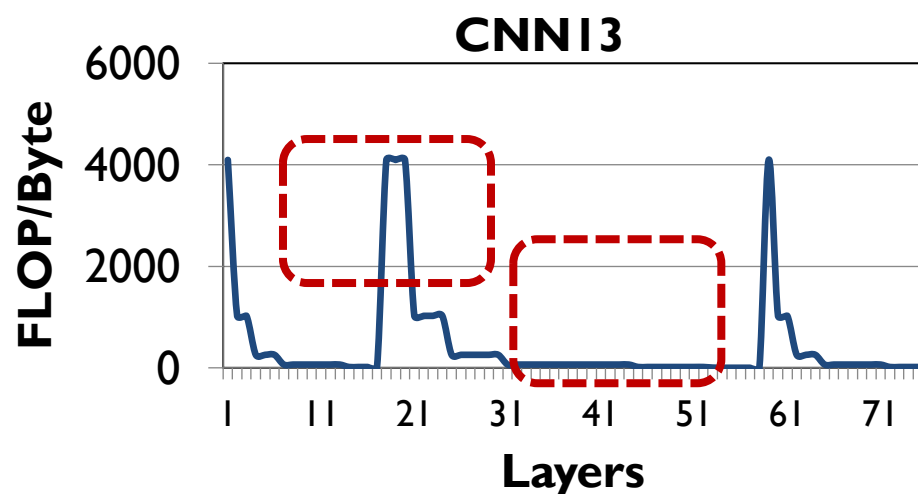
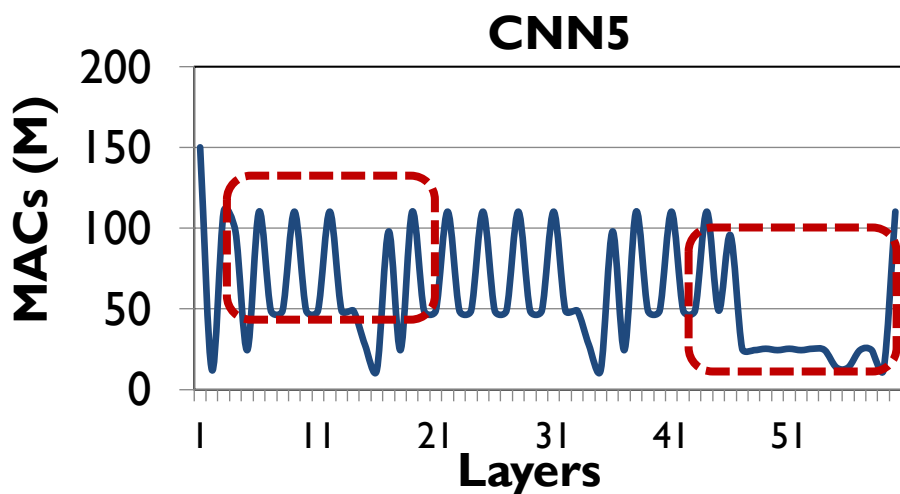

Variation in **MAC intensity**: up to **200x** across layers

Variation in **FLOP/Byte**: up to **244x** across layers

Mensa High-Level Overview

Edge TPU Accelerator

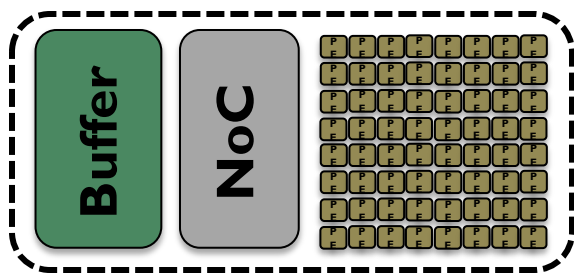
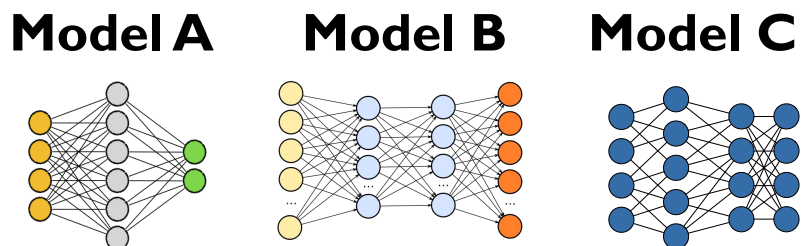

Monolithic Accelerator

Mensa

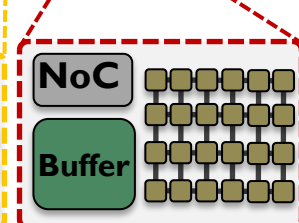
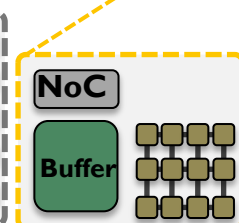
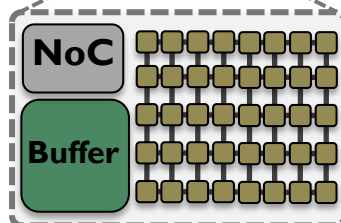
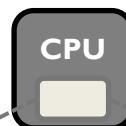
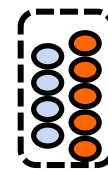
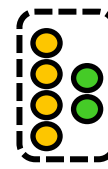
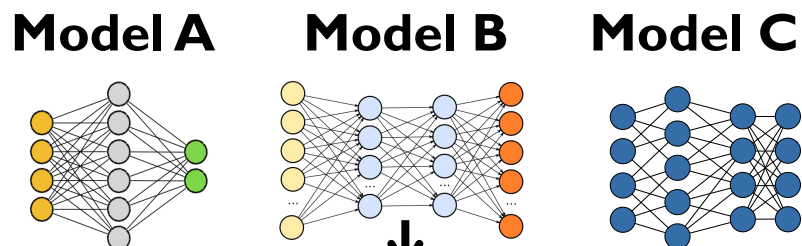

Acc. 1

Acc. 2

Acc. 3

Heterogeneous Accelerators

Identifying Layer Families

Key observation: the majority of layers group into a small number of layer families

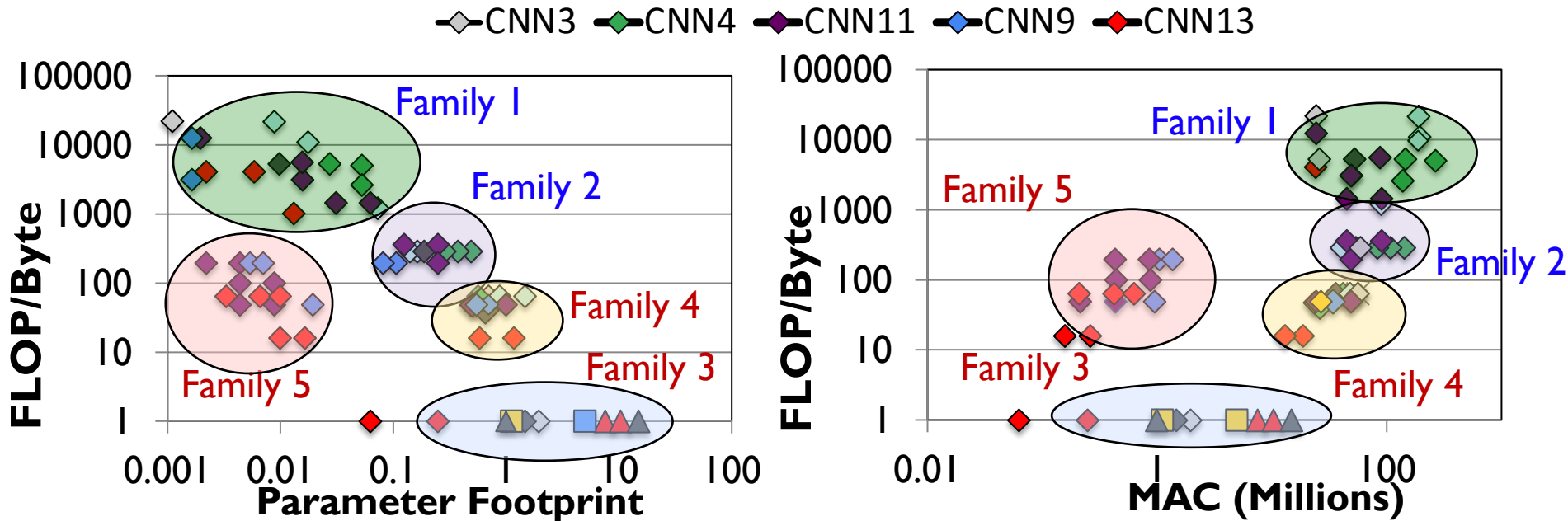

Families 1 & 2: low parameter footprint, high data reuse and **MAC** intensity
→ compute-centric layers

Families 3, 4 & 5: high parameter footprint, low data reuse and **MAC** intensity
→ data-centric layers

Mensa: Energy Reduction

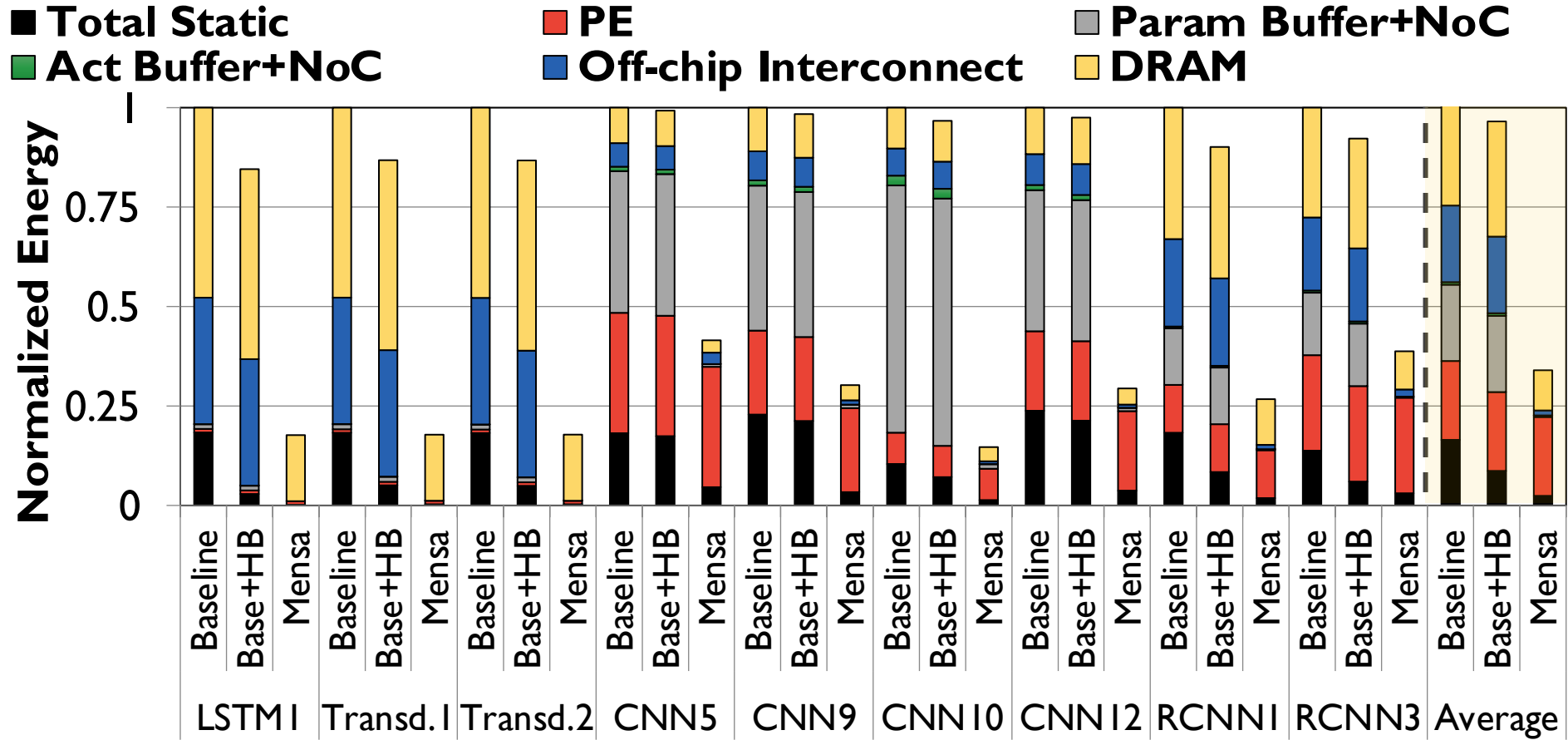

Mensa-G reduces energy consumption by 3.0X
 compared to the baseline Edge TPU

Mensa: Throughput Improvement

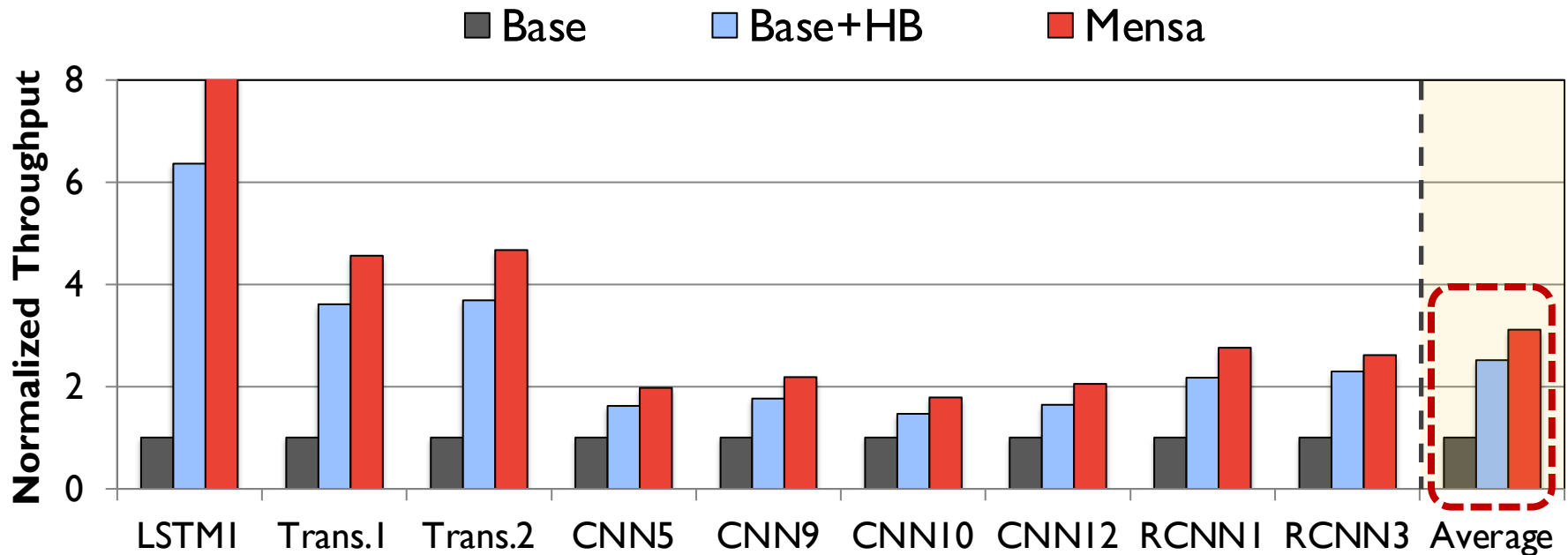

Mensa-G improves inference throughput by 3.1X compared to the baseline Edge TPU

Mensa: Highly-Efficient ML Inference

- Amirali Boroumand, Saugata Ghose, Berkin Akin, Ravi Narayanaswami, Geraldo F. Oliveira, Xiaoyu Ma, Eric Shiu, and Onur Mutlu,
"Google Neural Network Models for Edge Devices: Analyzing and Mitigating Machine Learning Inference Bottlenecks"
Proceedings of the 30th International Conference on Parallel Architectures and Compilation Techniques (PACT), Virtual, September 2021.
[[Slides \(pptx\)](#)] [[pdf](#)]
[[Talk Video](#) (14 minutes)]

Google Neural Network Models for Edge Devices: Analyzing and Mitigating Machine Learning Inference Bottlenecks

Amirali Boroumand^{†◇}

Saugata Ghose[‡]

Berkin Akin[§]

Ravi Narayanaswami[§]

Geraldo F. Oliveira^{*}

Xiaoyu Ma[§]

Eric Shiu[§]

Onur Mutlu^{*†}

[†]*Carnegie Mellon Univ.*

[◇]*Stanford Univ.*

[‡]*Univ. of Illinois Urbana-Champaign*

[§]*Google*

^{*}*ETH Zürich*

Accelerating Data-Intensive Workloads

- Junwhan Ahn, Sungjoo Yoo, Onur Mutlu, and Kiyoung Choi, **"PIM-Enabled Instructions: A Low-Overhead, Locality-Aware Processing-in-Memory Architecture"** *Proceedings of the 42nd International Symposium on Computer Architecture (ISCA)*, Portland, OR, June 2015. [[Slides \(pdf\)](#)] [[Lightning Session Slides \(pdf\)](#)]

PIM-Enabled Instructions: A Low-Overhead, Locality-Aware Processing-in-Memory Architecture

Junwhan Ahn Sungjoo Yoo Onur Mutlu[†] Kiyoung Choi

junwhan@snu.ac.kr, sungjoo.yoo@gmail.com, onur@cmu.edu, kchoi@snu.ac.kr

Seoul National University

[†]Carnegie Mellon University

FPGA-based Processing Near Memory

- Gagandeep Singh, Mohammed Alser, Damla Senol Cali, Dionysios Diamantopoulos, Juan Gómez-Luna, Henk Corporaal, and Onur Mutlu, ["FPGA-based Near-Memory Acceleration of Modern Data-Intensive Applications"](#)
IEEE Micro (IEEE MICRO), 2021.

FPGA-based Near-Memory Acceleration of Modern Data-Intensive Applications

Gagandeep Singh[◇] Mohammed Alser[◇] Damla Senol Cali[✕]

Dionysios Diamantopoulos[▽] Juan Gómez-Luna[◇]

Henk Corporaal^{*} Onur Mutlu^{◇✕}

[◇]*ETH Zürich* [✕]*Carnegie Mellon University*

^{*}*Eindhoven University of Technology* [▽]*IBM Research Europe*

Processing-in-Memory in the Real World

Processing-in-Memory Landscape Today

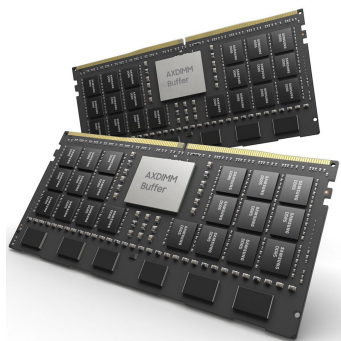
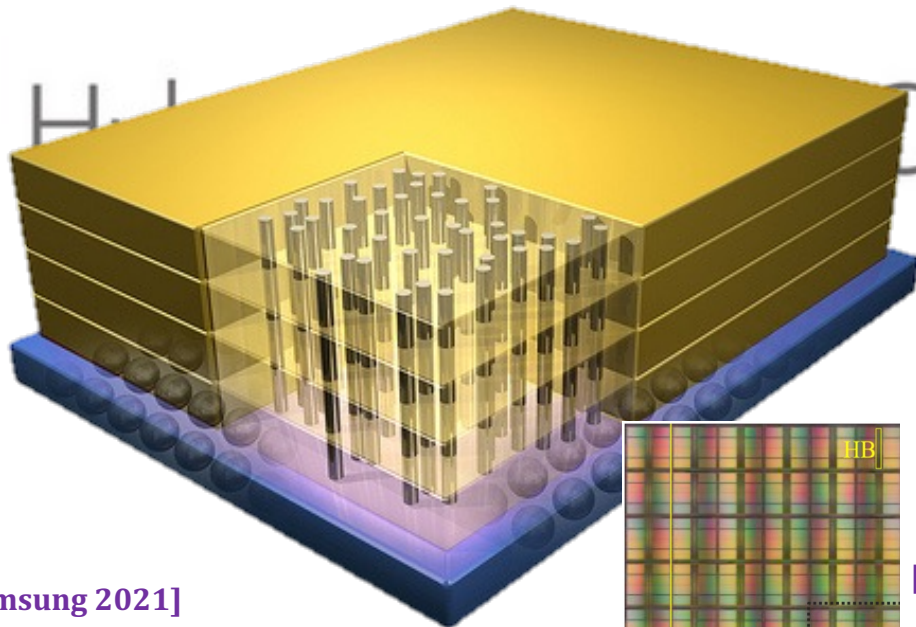

[Samsung 2021]

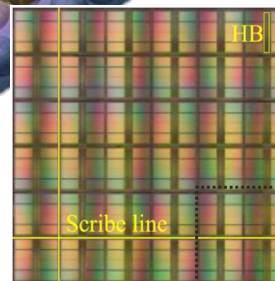

[Alibaba 2022]

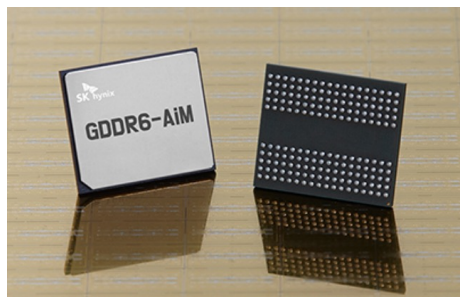

[SK Hynix 2022]

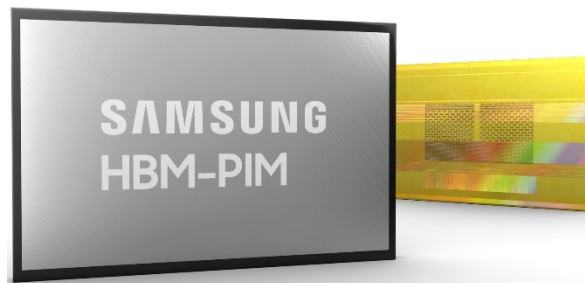

[Samsung 2021]

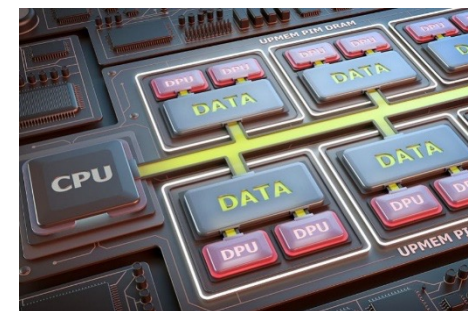

[UPMEM 2019]

UPMEM Processing-in-DRAM Engine (2019)

- **Processing in DRAM Engine**
- Includes **standard DIMM modules**, with a **large number of DPU processors** combined with DRAM chips.
- Replaces **standard DIMMs**
 - DDR4 R-DIMM modules
 - 8GB+128 DPUs (16 PIM chips)
 - Standard 2x-nm DRAM process
 - **Large amounts of** compute & memory bandwidth

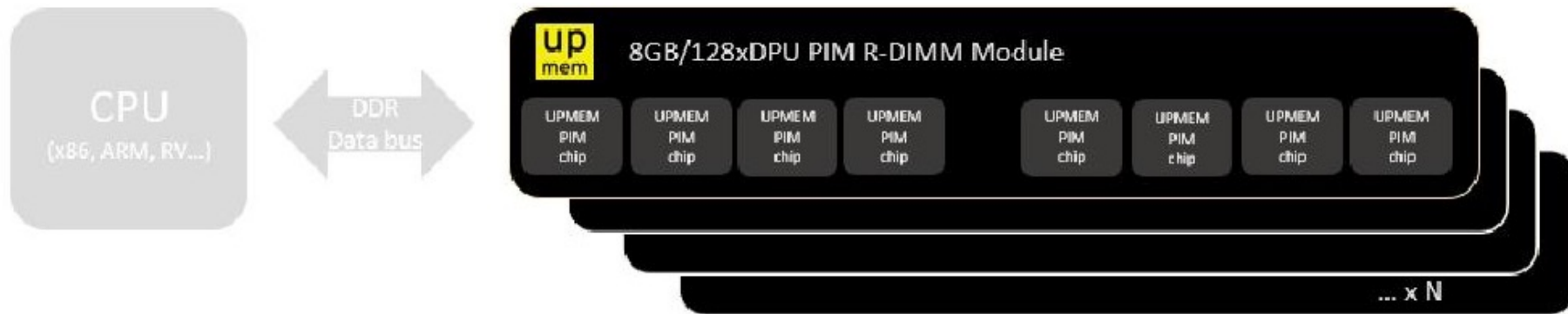

UPMEM Memory Modules

- E19: 8 chips DIMM (1 rank). DPUs @ 267 MHz
- P21: 16 chips DIMM (2 ranks). DPUs @ 350 MHz

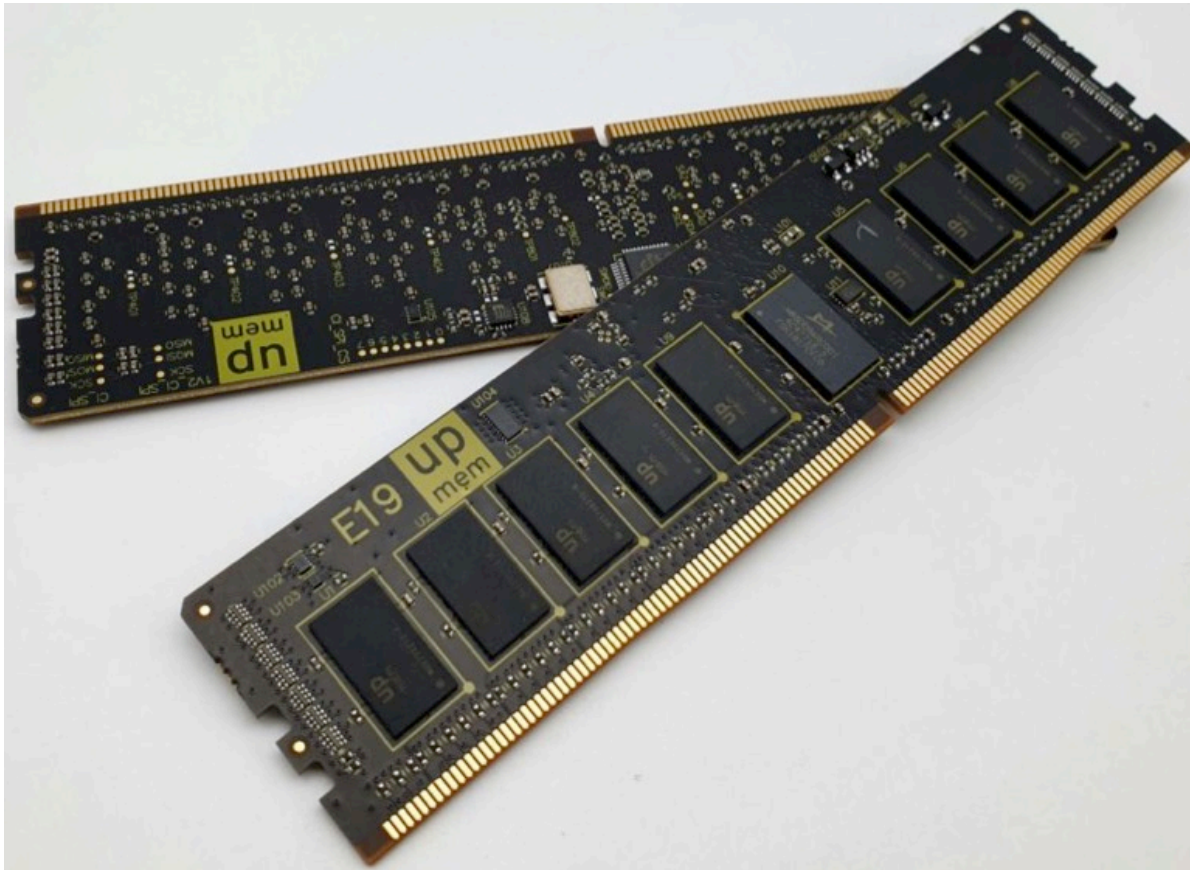

2,560-DPU Processing-in-Memory System

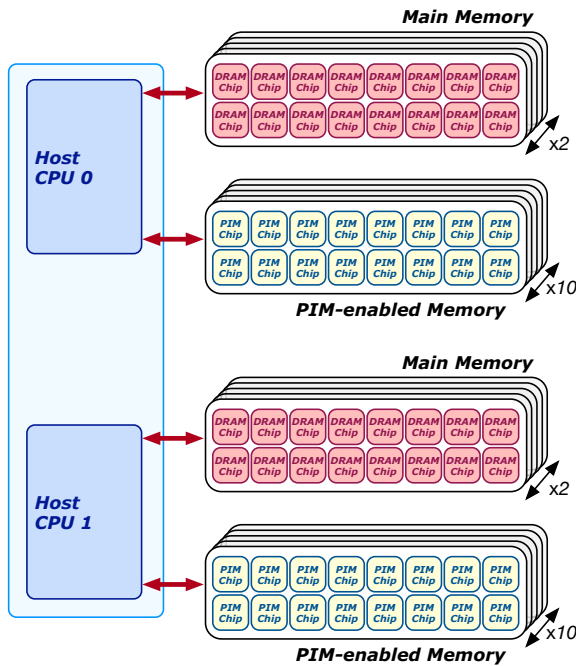

Benchmarking a New Paradigm: An Experimental Analysis of a Real Processing-in-Memory Architecture

JUAN GÓMEZ-LUNA, ETH Zürich, Switzerland
 IZZAT EL HAJJ, American University of Beirut, Lebanon
 IVAN FERNANDEZ, ETH Zürich, Switzerland and University of Malaga, Spain
 CHRISTINA GIANNOULA, ETH Zürich, Switzerland and NTUA, Greece
 GERALDO F. OLIVEIRA, ETH Zürich, Switzerland
 ONUR MUTLU, ETH Zürich, Switzerland

Many modern workloads, such as neural networks, databases, and graph processing, are fundamentally memory-bound. For such workloads, the data movement between main memory and CPU cores imposes a significant overhead in terms of both latency and energy. A major reason is that this communication happens through a narrow bus with high latency and limited bandwidth, and the low data reuse in memory-bound workloads is insufficient to amortize the cost of main memory access. Fundamentally addressing this *data movement bottleneck* requires a paradigm where the memory system assumes an active role in computing by integrating processing capabilities. This paradigm is known as *processing-in-memory (PIM)*.

Recent research explores different forms of PIM architectures, motivated by the emergence of new 3D-stacked memory technologies that integrate memory with a logic layer where processing elements can be easily placed. Past works evaluate these architectures in simulation or, at best, with simplified hardware prototypes. In contrast, the UPMEM company has designed and manufactured the first publicly-available real-world PIM architecture. The UPMEM PIM architecture combines traditional DRAM memory arrays with general-purpose in-order cores, called *DRAM Processing Units (DPUs)*, integrated in the same chip.

This paper provides the first comprehensive analysis of the first publicly-available real-world PIM architecture. We make two key contributions. First, we conduct an experimental characterization of the UPMEM-based PIM system using microbenchmarks to assess various architecture limits such as compute throughput and memory bandwidth, yielding new insights. Second, we present *PrIM (Processing-In-Memory benchmarks)*, a benchmark suite of 16 workloads from different application domains (e.g., dense/sparse linear algebra, databases, data analytics, graph processing, neural networks, bioinformatics, image processing), which we identify as memory-bound. We evaluate the performance and scaling characteristics of PrIM benchmarks on the UPMEM PIM architecture, and compare their performance and energy consumption to their state-of-the-art CPU and GPU counterparts. Our extensive evaluation conducted on two real UPMEM-based PIM systems with 440 and 2,556 DPUs provides new insights about suitability of different workloads to the PIM system, programming recommendations for software designers, and suggestions and hints for hardware and architecture designers of future PIM systems.

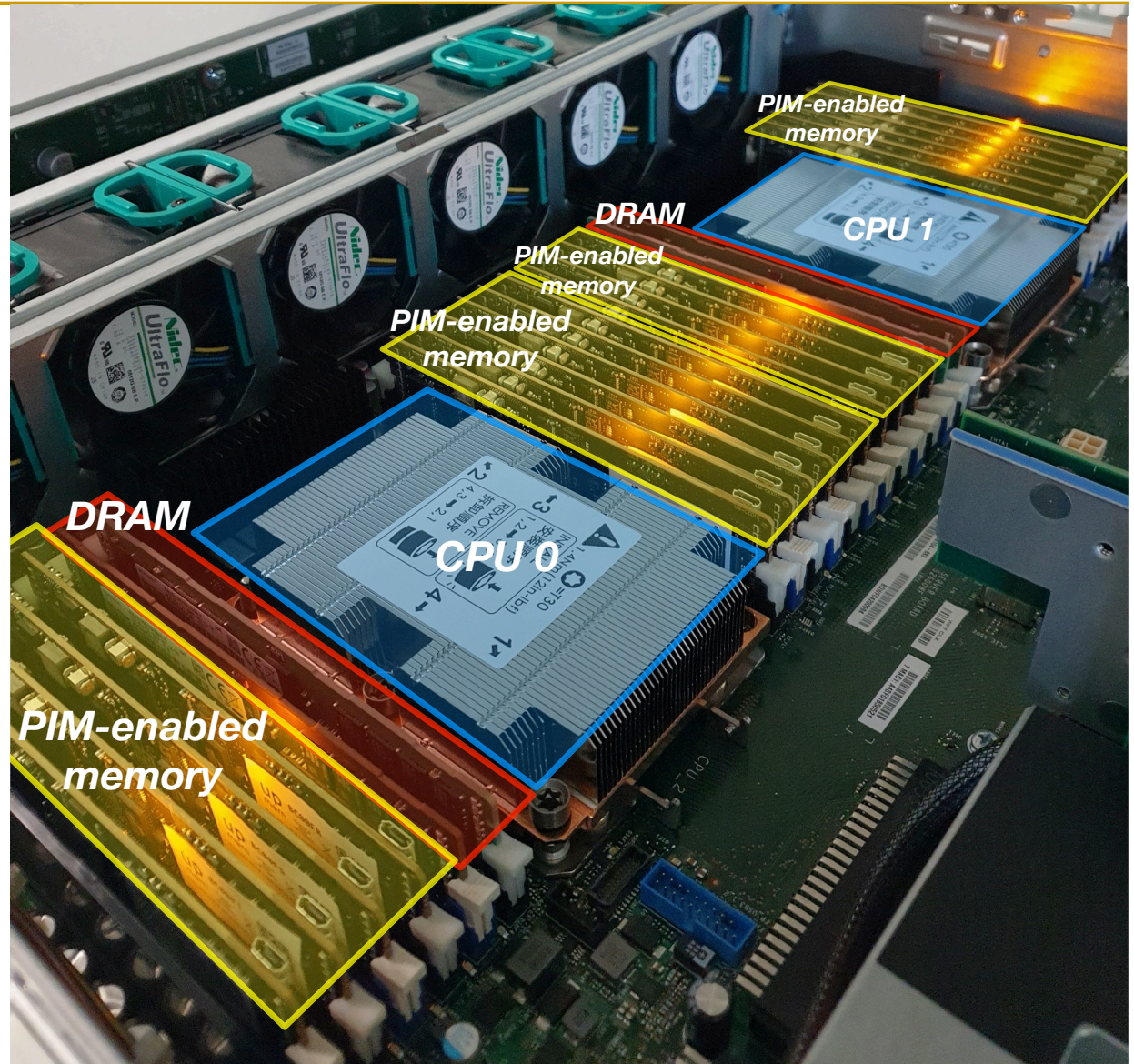

More on the UPMEM PIM System

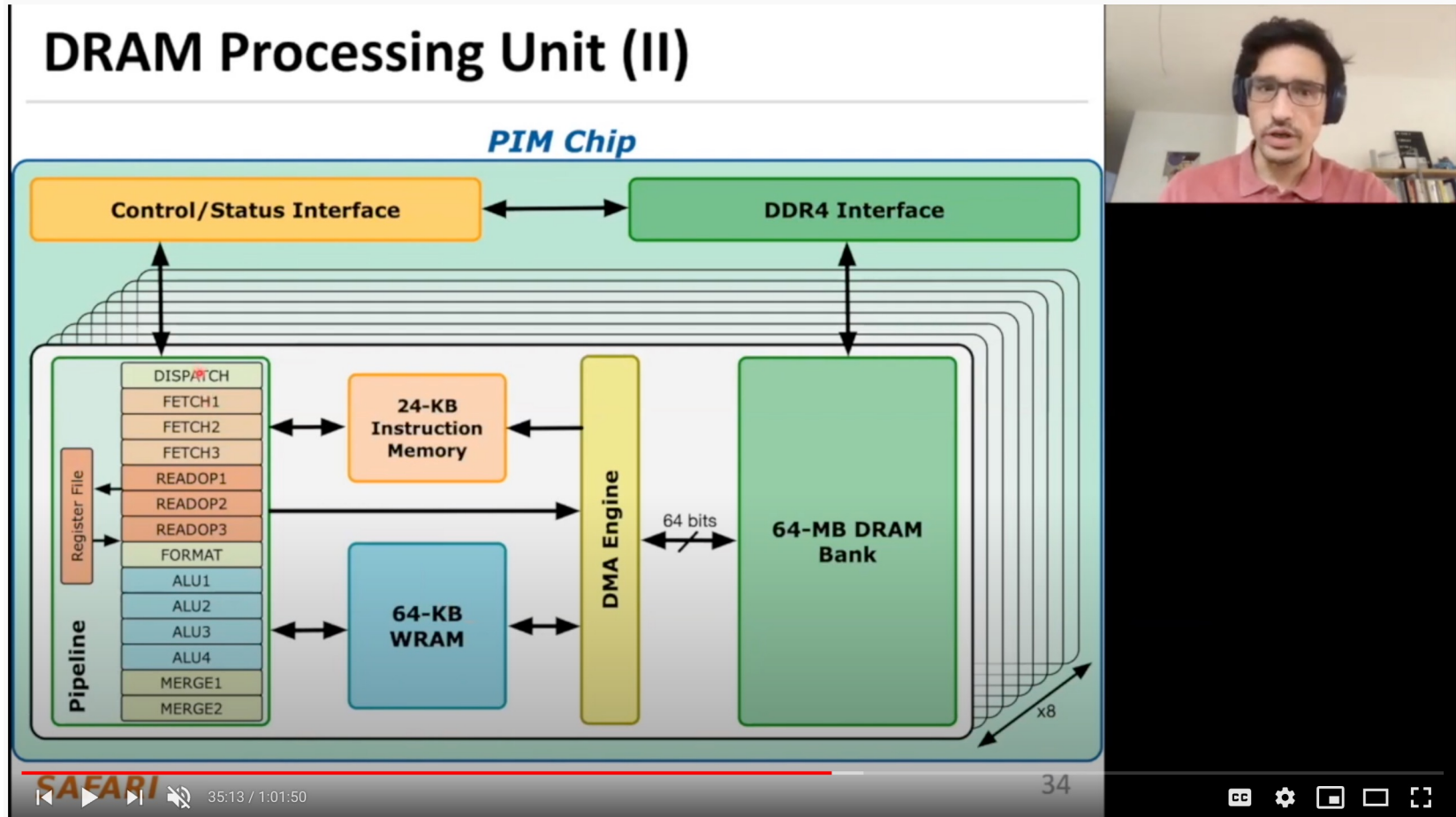

ETH ZÜRICH HAUPTGEBÄUDE

Computer Architecture - Lecture 12d: Real Processing-in-DRAM with UPMEM (ETH Zürich, Fall 2020)

1,120 views • Oct 31, 2020

30 0 SHARE SAVE ...



Onur Mutlu Lectures
16.7K subscribers

ANALYTICS

EDIT VIDEO

Benchmarking a New Paradigm: Experimental Analysis and Characterization of a Real Processing-in-Memory System

**JUAN GÓMEZ-LUNA¹, IZZAT EL HAJJ², IVAN FERNANDEZ^{1,3}, CHRISTINA GIANNOULA^{1,4},
GERALDO F. OLIVEIRA¹, AND ONUR MUTLU¹**

¹ETH Zürich

²American University of Beirut

³University of Malaga

⁴National Technical University of Athens

Corresponding author: Juan Gómez-Luna (e-mail: juang@ethz.ch).

<https://arxiv.org/pdf/2105.03814.pdf>

<https://github.com/CMU-SAFARI/prim-benchmarks>

PrIM Benchmarks: Application Domains

| Domain | Benchmark | Short name |
|-----------------------|-------------------------------|------------|
| Dense linear algebra | Vector Addition | VA |
| | Matrix-Vector Multiply | GEMV |
| Sparse linear algebra | Sparse Matrix-Vector Multiply | SpMV |
| Databases | Select | SEL |
| | Unique | UNI |
| Data analytics | Binary Search | BS |
| | Time Series Analysis | TS |
| Graph processing | Breadth-First Search | BFS |
| Neural networks | Multilayer Perceptron | MLP |
| Bioinformatics | Needleman-Wunsch | NW |
| Image processing | Image histogram (short) | HST-S |
| | Image histogram (large) | HST-L |
| Parallel primitives | Reduction | RED |
| | Prefix sum (scan-scan-add) | SCAN-SSA |
| | Prefix sum (reduce-scan-scan) | SCAN-RSS |
| | Matrix transposition | TRNS |

PrIM Benchmarks are Open Source

- All microbenchmarks, benchmarks, and scripts
- <https://github.com/CMU-SAFARI/prim-benchmarks>

CMU-SAFARI / prim-benchmarks

Unwatch 2 Star 2 Fork 1

<> Code Issues Pull requests Actions Projects Wiki Security Insights Settings

main prim-benchmarks / README.md Go to file

Juan Gomez Luna PrIM -- first commit Latest commit 3de4b49 9 days ago History

1 contributor

168 lines (132 sloc) | 5.79 KB Raw Blame

PrIM (Processing-In-Memory Benchmarks)

PrIM is the first benchmark suite for a real-world processing-in-memory (PIM) architecture. PrIM is developed to evaluate, analyze, and characterize the first publicly-available real-world processing-in-memory (PIM) architecture, the [UPMEM PIM](#) architecture. The UPMEM PIM architecture combines traditional DRAM memory arrays with general-purpose in-order cores, called DRAM Processing Units (DPUs), integrated in the same chip.

PrIM provides a common set of workloads to evaluate the UPMEM PIM architecture with and can be useful for programming, architecture and system researchers all alike to improve multiple aspects of future PIM hardware and software. The workloads have different characteristics, exhibiting heterogeneity in their memory access patterns, operations and data types, and communication patterns. This repository also contains baseline CPU and GPU implementations of PrIM benchmarks for comparison purposes.

Prim also includes a set of microbenchmarks can be used to assess various architecture limits such as compute throughput and memory bandwidth.

ML Training on a Real PIM System

Machine Learning Training on a Real Processing-in-Memory System

Juan Gómez-Luna¹ Yuxin Guo¹ Sylvan Brocard² Julien Legriel²
Remy Cimadomo² Geraldo F. Oliveira¹ Gagandeep Singh¹ Onur Mutlu¹

¹ETH Zürich ²UPMEM

An Experimental Evaluation of Machine Learning Training on a Real Processing-in-Memory System

Juan Gómez-Luna¹ Yuxin Guo¹ Sylvan Brocard² Julien Legriel²
Remy Cimadomo² Geraldo F. Oliveira¹ Gagandeep Singh¹ Onur Mutlu¹

¹ETH Zürich ²UPMEM

Short version: <https://arxiv.org/pdf/2206.06022.pdf>

Long version: <https://arxiv.org/pdf/2207.07886.pdf>

<https://www.youtube.com/watch?v=qeukNs5XI3g&t=11226s>

ML Training on a Real PIM System

- Need to optimize data representation
 - (1) fixed-point
 - (2) quantization
 - (3) hybrid precision
- Use **lookup tables (LUTs)** to implement complex functions (e.g., sigmoid)
- Optimize data placement & layout for **streaming**
- Large speedups: **2.8X/27X vs. CPU, 1.3x/3.2x vs. GPU**

ML Training on Real PIM Talk Video

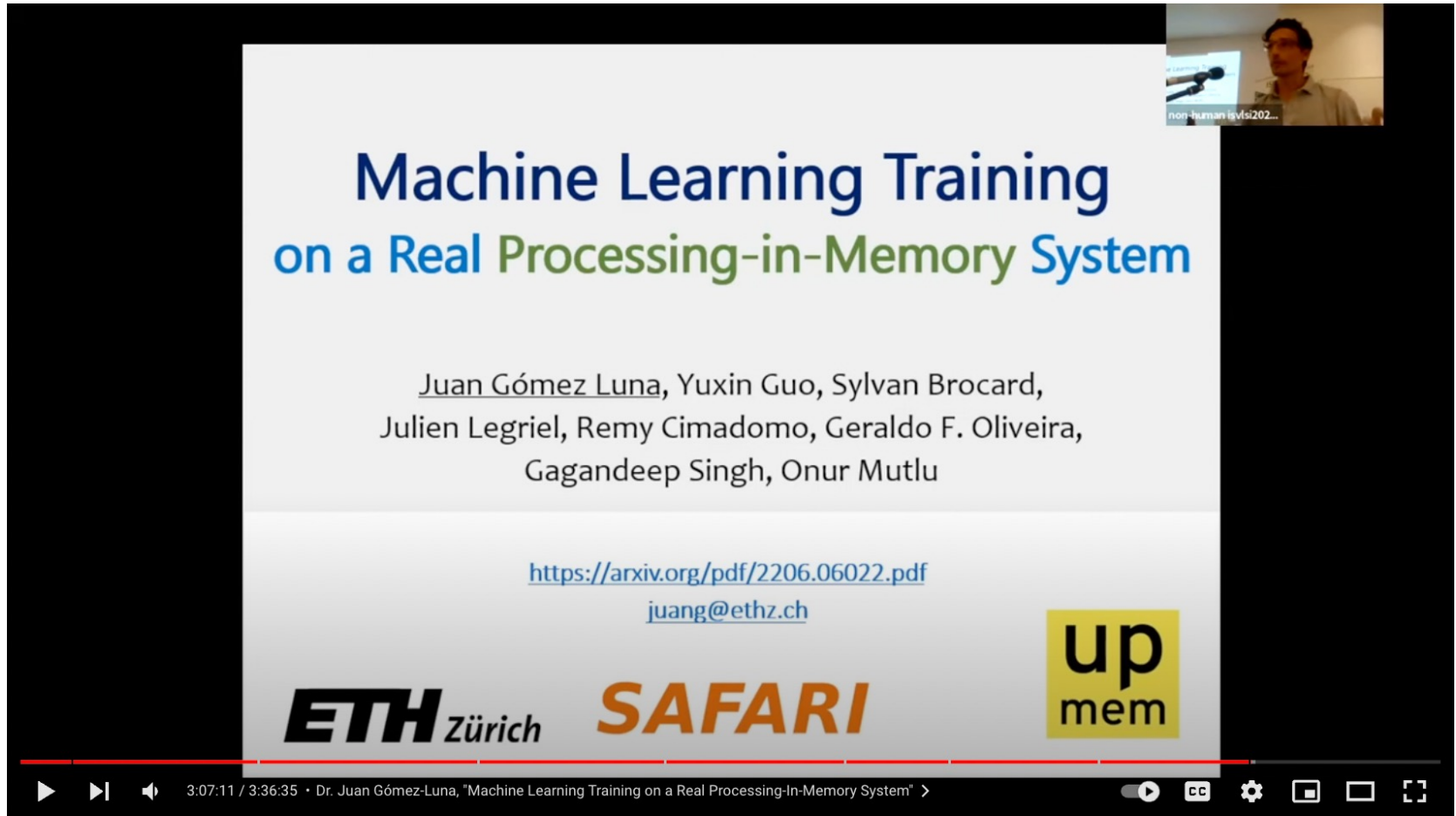

**Machine Learning Training
on a Real Processing-in-Memory System**

Juan Gómez Luna, Yuxin Guo, Sylvan Brocard,
Julien Legriél, Remy Cimadomo, Geraldo F. Oliveira,
Gagandeep Singh, Onur Mutlu

<https://arxiv.org/pdf/2206.06022.pdf>
juang@ethz.ch

ETH Zürich **SAFARI** up mem

3:07:11 / 3:36:35 • Dr. Juan Gómez-Luna, "Machine Learning Training on a Real Processing-In-Memory System" >

ISVLSI 2022 Special Session on Processing-in-Memory

1,345 views • Premiered Aug 9, 2022

61 DISLIKE SHARE DOWNLOAD CLIP SAVE ...

 **Onur Mutlu Lectures**
26.9K subscribers

ANALYTICS EDIT VIDEO

SpMV Multiplication on Real PIM Systems

- Appears in SIGMETRICS 2022

***SparseP*: Towards Efficient Sparse Matrix Vector Multiplication on Real Processing-In-Memory Systems**

CHRISTINA GIANNOULA, ETH Zürich, Switzerland and National Technical University of Athens, Greece

IVAN FERNANDEZ, ETH Zürich, Switzerland and University of Malaga, Spain

JUAN GÓMEZ-LUNA, ETH Zürich, Switzerland

NECTARIOS KOZIRIS, National Technical University of Athens, Greece

GEORGIOS GOUMAS, National Technical University of Athens, Greece

ONUR MUTLU, ETH Zürich, Switzerland

<https://arxiv.org/pdf/2201.05072.pdf>

<https://github.com/CMU-SAFARI/SparseP>

Sequence Alignment on Real PIM Systems

- Safaa Diab, Amir Nassereldine, Mohammed Alser, Juan Gómez Luna, Onur Mutlu, and Izzat El Hajj,
"A Framework for High-throughput Sequence Alignment using Real Processing-in-Memory Systems"
Bioinformatics, [published online on] 27 March 2023.
[[Online link at Bioinformatics Journal](#)]
[[arXiv preprint](#)]
[[AiM Source Code](#)]

A Framework for High-throughput Sequence Alignment using Real Processing-in-Memory Systems

Safaa Diab¹ Amir Nassereldine¹ Mohammed Alser² Juan Gómez Luna²
Onur Mutlu² Izzat El Hajj¹

¹American University of Beirut ²ETH Zürich

<https://github.com/CMU-SAFARI/alignment-in-memory>

<https://arxiv.org/pdf/2208.01243.pdf>

Summary

- Sequence alignment on traditional systems is limited by the **memory bandwidth bottleneck**
- **Processing-in-memory (PIM)** overcomes this bottleneck by placing cores near the memory
- Our framework, **Alignment-in-Memory (AIM)**, is a PIM framework that supports multiple alignment algorithms (NW, SWG, GenASM, WFA)
 - Implemented on UPMEM, the first real PIM system
- Results show **substantial speedups over both CPUs (1.8X-28X) and GPUs (1.2X-2.7X)**
- AIM is available at:
 - <https://github.com/CMU-SAFARI/alignment-in-memory>

Samsung Function-in-Memory DRAM (2021)



Samsung Develops Industry's First High Bandwidth Memory with AI Processing Power

Korea on February 17, 2021

Audio



Share



The new architecture will deliver over twice the system performance and reduce energy consumption by more than 70%

Samsung Electronics, the world leader in advanced memory technology, today announced that it has developed the industry's first High Bandwidth Memory (HBM) integrated with artificial intelligence (AI) processing power – the HBM-PIM. **The new processing-in-memory (PIM) architecture brings powerful AI computing capabilities inside high-performance memory, to accelerate large-scale processing in data centers, high performance computing (HPC) systems and AI-enabled mobile applications.**

Kwangil Park, senior vice president of Memory Product Planning at Samsung Electronics stated, "Our groundbreaking HBM-PIM is the industry's first programmable PIM solution tailored for diverse AI-driven workloads such as HPC, training and inference. We plan to build upon this breakthrough by further collaborating with AI solution providers for even more advanced PIM-powered applications."

Samsung Function-in-Memory DRAM (2021)

■ FIMDRAM based on HBM2

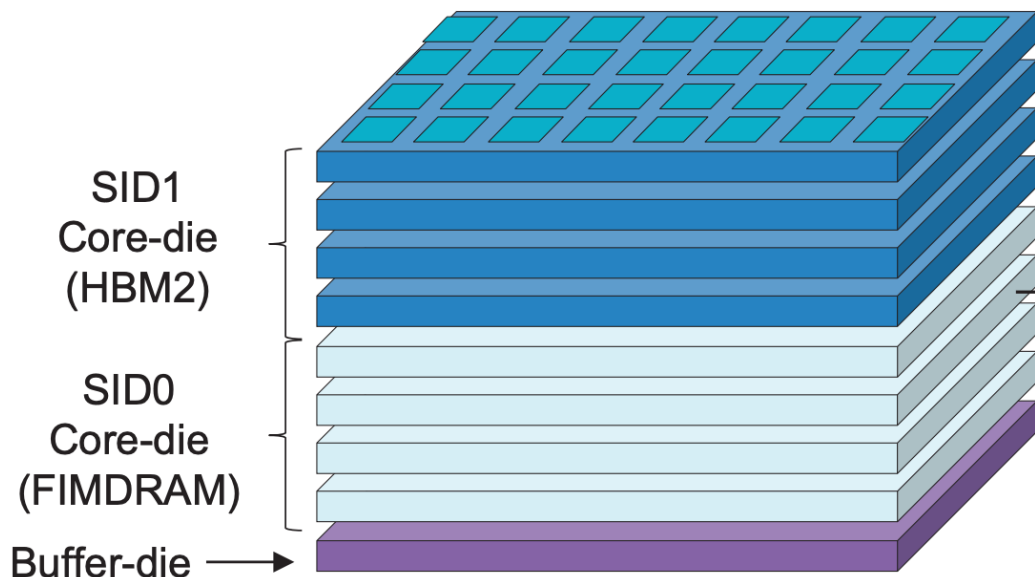

[3D Chip Structure of HBM with FIMDRAM]

Chip Specification

128DQ / 8CH / 16 banks / BL4

32 PCU blocks (1 FIM block/2 banks)

1.2 TFLOPS (4H)

**FP16 ADD /
Multiply (MUL) /
Multiply-Accumulate (MAC) /
Multiply-and- Add (MAD)**

ISSCC 2021 / SESSION 25 / DRAM / 25.4

25.4 A 20nm 6GB Function-In-Memory DRAM, Based on HBM2 with a 1.2TFLOPS Programmable Computing Unit Using Bank-Level Parallelism, for Machine Learning Applications

Young-Cheon Kwon¹, Suk Han Lee¹, Jaehoon Lee¹, Sang-Hyuk Kwon¹, Je Min Ryu¹, Jong-Pil Son¹, Seongil O¹, Hak-Soo Yu¹, Haesuk Lee¹, Soo Young Kim¹, Youngmin Cho¹, Jin Guk Kim¹, Jongyoon Choi¹, Hyun-Sung Shin¹, Jin Kim¹, BengSeng Phuah¹, HyoungMin Kim¹, Myeong Jun Song¹, Ahn Choi¹, Daeho Kim¹, SooYoung Kim¹, Eun-Bong Kim¹, David Wang², Shinhaeng Kang¹, Yuhwan Ro³, Seungwoo Seo³, JoonHo Song³, Jaeyoun Youn¹, Kyomin Sohn¹, Nam Sung Kim¹

¹Samsung Electronics, Hwaseong, Korea

²Samsung Electronics, San Jose, CA

³Samsung Electronics, Suwon, Korea

Samsung Function-in-Memory DRAM (2021)

Programmable Computing Unit

■ Configuration of PCU block

- Interface unit to control data flow
- Execution unit to perform operations
- Register group
 - 32 entries of CRF for instruction memory
 - 16 GRF for weight and accumulation
 - 16 SRF to store constants for MAC operations

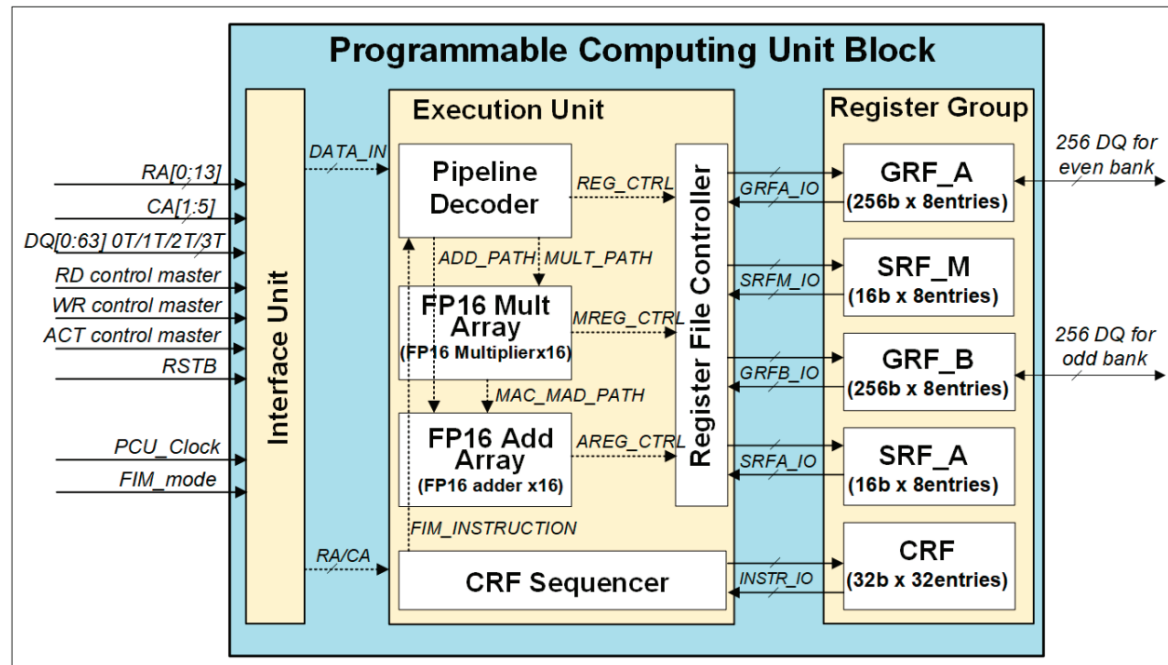

[Block diagram of PCU in FIMDRAM]

ISSCC 2021 / SESSION 25 / DRAM / 25.4

25.4 A 20nm 6GB Function-in-Memory DRAM, Based on HBM2 with a 1.2TFLOPS Programmable Computing Unit Using Bank-Level Parallelism, for Machine Learning Applications

Young-Cheon Kwon¹, Suk Han Lee¹, Jaehoon Lee¹, Sang-Hyuk Kwon¹, Je Min Ryu¹, Jong-Pil Son¹, Seongil O¹, Hak-Soo Yu¹, Haesuk Lee¹, Soo Young Kim¹, Youngmin Cho¹, Jin Guk Kim¹, Jongyoon Choi¹, Hyun-Sung Shin¹, Jin Kim¹, BengSeng Phuah¹, HyoungMin Kim¹, Myeong Jun Song¹, Ahn Choi¹, Daeho Kim¹, SooYoung Kim¹, Eun-Bong Kim¹, David Wang¹, Shinhaeng Kang¹, Yuhwan Ro¹, Seungwoo Seo¹, JoonHo Song¹, Jaeyoun Youn¹, Kyomin Sohn¹, Nam Sung Kim¹

¹Samsung Electronics, Hwasong, Korea
²Samsung Electronics, San Jose, CA
³Samsung Electronics, Suwon, Korea

Samsung Function-in-Memory DRAM (2021)

[Available instruction list for FIM operation]

| Type | CMD | Description |
|----------------|------|-----------------------------|
| Floating Point | ADD | FP16 addition |
| | MUL | FP16 multiplication |
| | MAC | FP16 multiply-accumulate |
| | MAD | FP16 multiply and add |
| Data Path | MOVE | Load or store data |
| | FILL | Copy data from bank to GRFs |
| Control Path | NOP | Do nothing |
| | JUMP | Jump instruction |
| | EXIT | Exit instruction |

ISSCC 2021 / SESSION 25 / DRAM / 25.4

25.4 A 20nm 6GB Function-in-Memory DRAM, Based on HBM2 with a 1.2TFLOPS Programmable Computing Unit Using Bank-Level Parallelism, for Machine Learning Applications

Young-Cheon Kwon¹, Suk Han Lee¹, Jaehoon Lee¹, Sang-Hyuk Kwon¹, Je Min Ryu¹, Jong-Pil Son¹, Seongil O¹, Hak-Soo Yu¹, Haesuk Lee¹, Soo Young Kim¹, Youngmin Cho¹, Jin Guk Kim¹, Jongyoon Choi¹, Hyun-Sung Shin¹, Jin Kim¹, BengSeng Phuah¹, HyoungMin Kim¹, Myeong Jun Song¹, Ahn Choi¹, Daeho Kim¹, SooYoung Kim¹, Eun-Bong Kim¹, David Wang¹, Shinhaeng Kang¹, Yuhwan Ro¹, Seungwoo Seo¹, JoonHo Song¹, Jaeyoun Youn¹, Kyomin Sohn¹, Nam Sung Kim¹

¹Samsung Electronics, Hwasong, Korea
²Samsung Electronics, San Jose, CA
³Samsung Electronics, Suwon, Korea

Samsung Function-in-Memory DRAM (2021)

Chip Implementation

- Mixed design methodology to implement FIMDRAM
 - Full-custom + Digital RTL

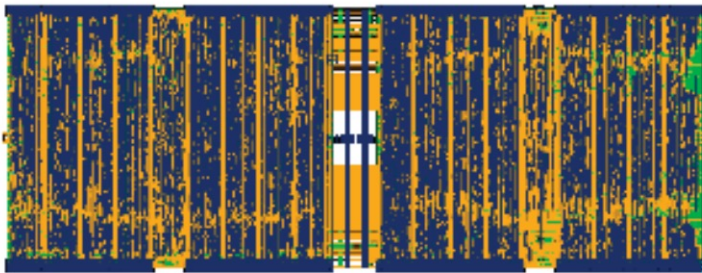

[Digital RTL design for PCU block]

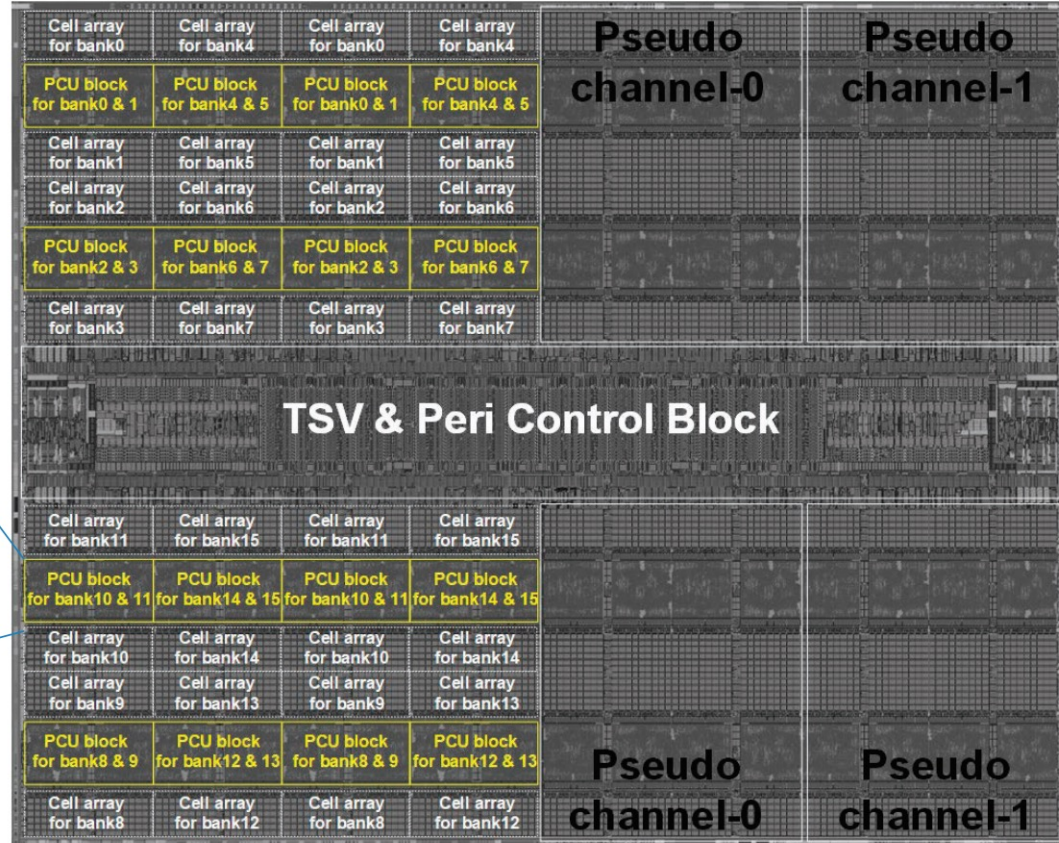

ISSCC 2021 / SESSION 25 / DRAM / 25.4

25.4 A 20nm 6Gb Function-In-Memory DRAM, Based on HBM2 with a 1.2TFLOPS Programmable Computing Unit Using Bank-Level Parallelism, for Machine Learning Applications

Young-Cheon Kwon¹, Suk Han Lee¹, Jaehoon Lee¹, Sang-Hyuk Kwon¹, Je Min Ryu¹, Jong-Pil Son¹, Seongil O¹, Hak-Soo Yu¹, Haesuk Lee¹, Soo Young Kim¹, Youngmin Cho¹, Jin Guk Kim¹, Jongyeon Choi¹, Hyun-Sung Shim¹, Jin Kim¹, BengSeng Phuah¹, HyoungMin Kim¹, Myeong Jun Song¹, Ahn Choi¹, Daeho Kim¹, SooYoung Kim¹, Eun-Bong Kim¹, David Wang², Shrinraeng Kang³, Yulwan Ro³, Seungwoo Seo³, JoonHo Song³, Jaeyoun Youn¹, Kyomin Sohn¹, Nam Sung Kim¹

¹Samsung Electronics, Hwaseong, Korea
²Samsung Electronics, San Jose, CA
³Samsung Electronics, Suwon, Korea

Samsung PNM Solutions for Generative AI (2023)

- Main target: **transformer** decoders used in **ChatGPT, GPT-3**
 - **Compute-bound step**: Summarization
 - **Memory-bound step**: Generation
 - Most of the execution time is spent on the **memory copy** from the **host CPU memory** to the **CPU memory**
- **GEMV** portion can be **60%-80%** of total generation latency, which is the target of PIM/PNM

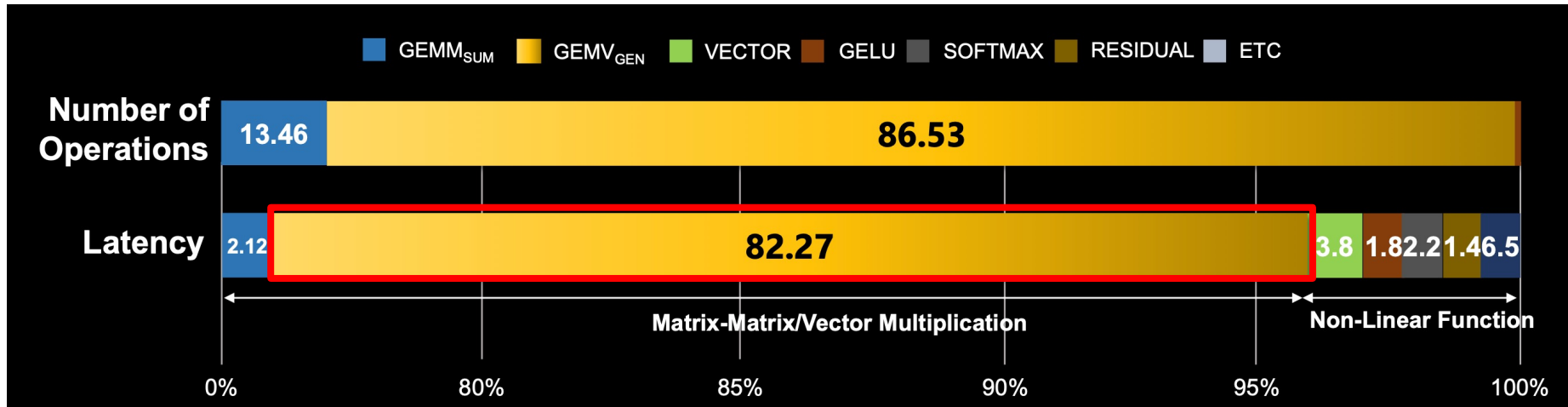

Solution I: Samsung's HBM-PIM (2023)

- AMD MI100 GPUs fabricated with HBM-PIM
- Experimental setup: GPT-J (6B, 32 input tokens), single AMD MI100-PIM GPU

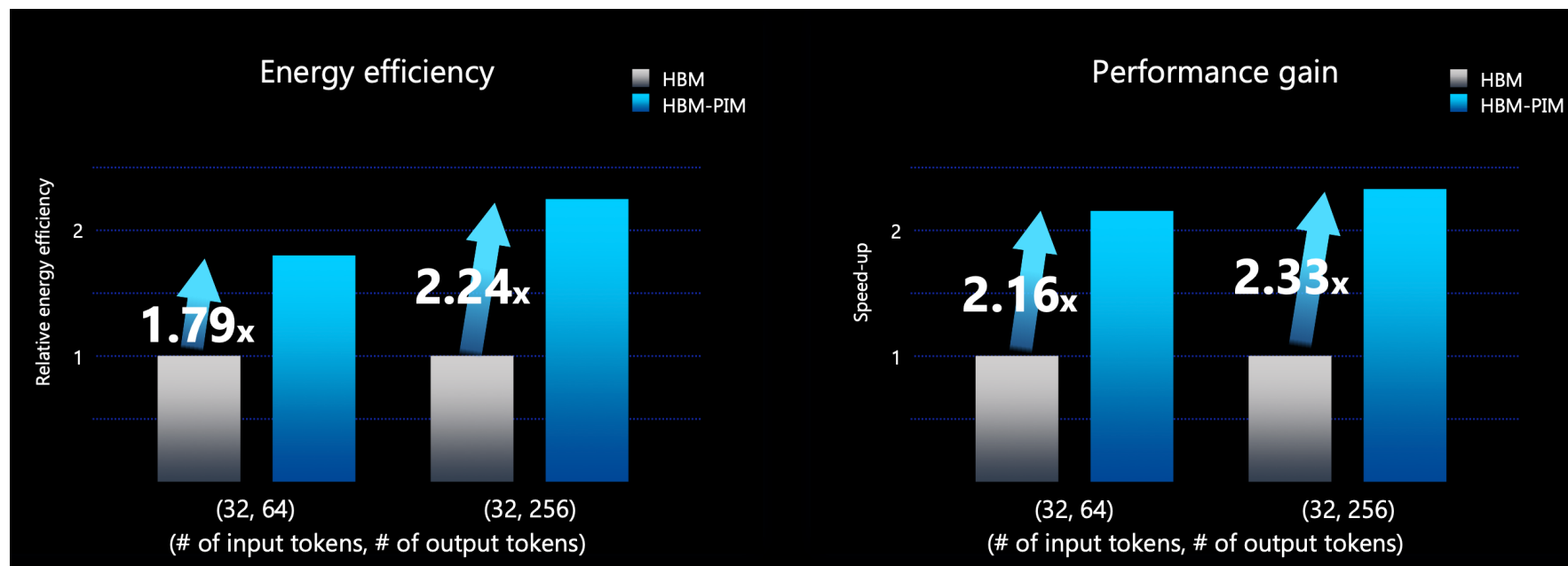

- GPT can be accelerated by more than 2x over baseline

Solution II: Samsung's LPDDR-PIM (2023)

- PIM for on-device generative AI
 - Datacenter **costs** and **power consumption** are increasing due to the growing demand for cloud AI
- LPDDR-PIM improves **battery life** by preventing memory over-provisioning just for bandwidth

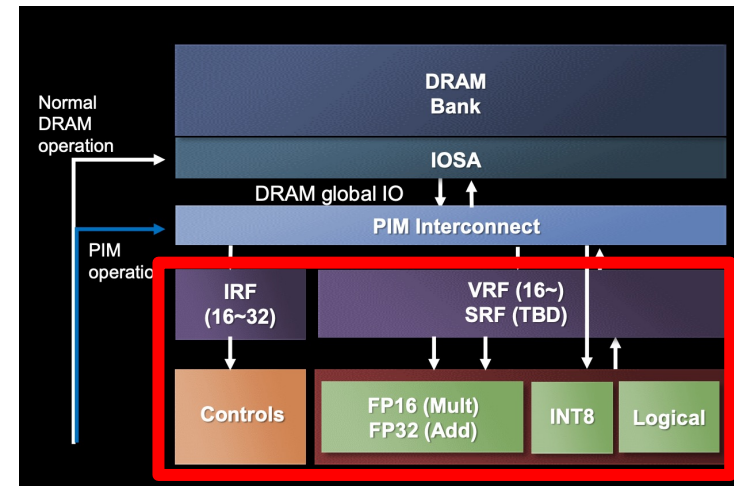
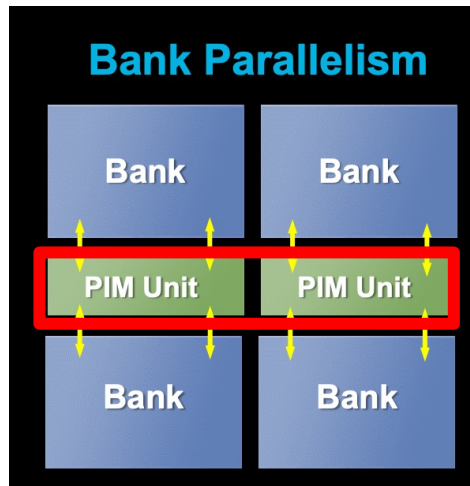

- 4.47x **performance gains** and 70.6% **energy reduction** in GPT-2

Solution III: Samsung's CXL-PNM (2023)

- A CXL-based processing-near-memory solution
 - Improves **capacity**, **bandwidth**, and **power**
 - Large-scale large-language models are often **capacity-bound**

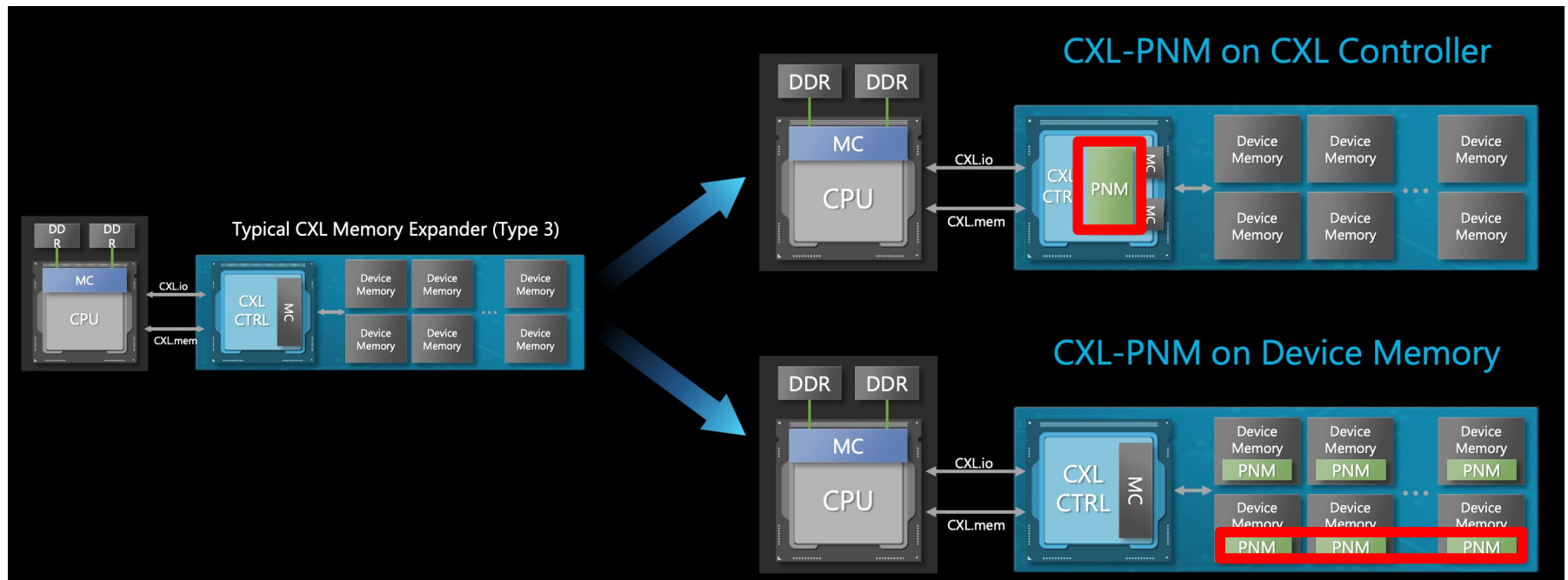

- Multiple CXL-PNM can offer **4.4x higher energy efficiency** and **53% higher throughput** than multiple GPUs

Samsung AxDIMM (2021)

- DDRx-PIM
 - Deep learning recommendation system

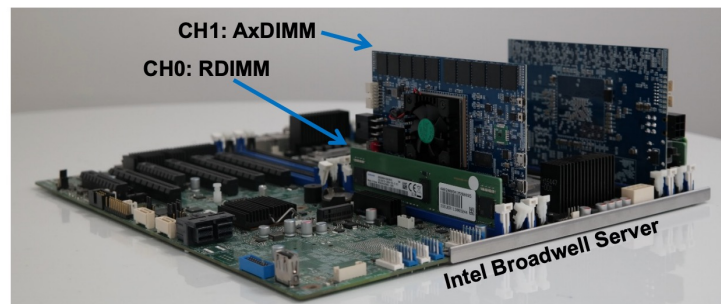
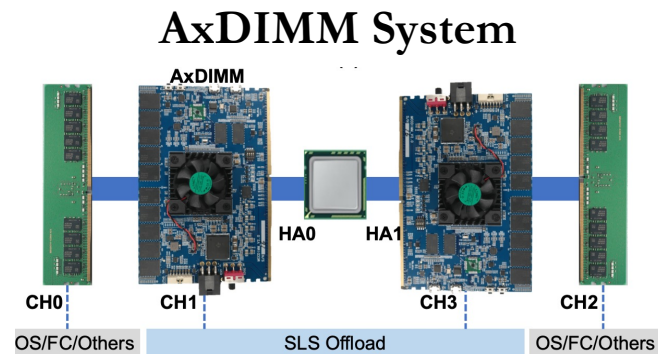
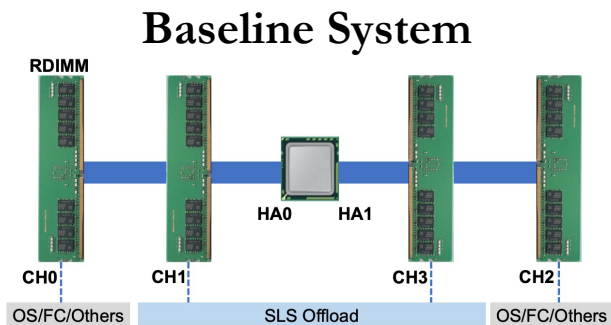
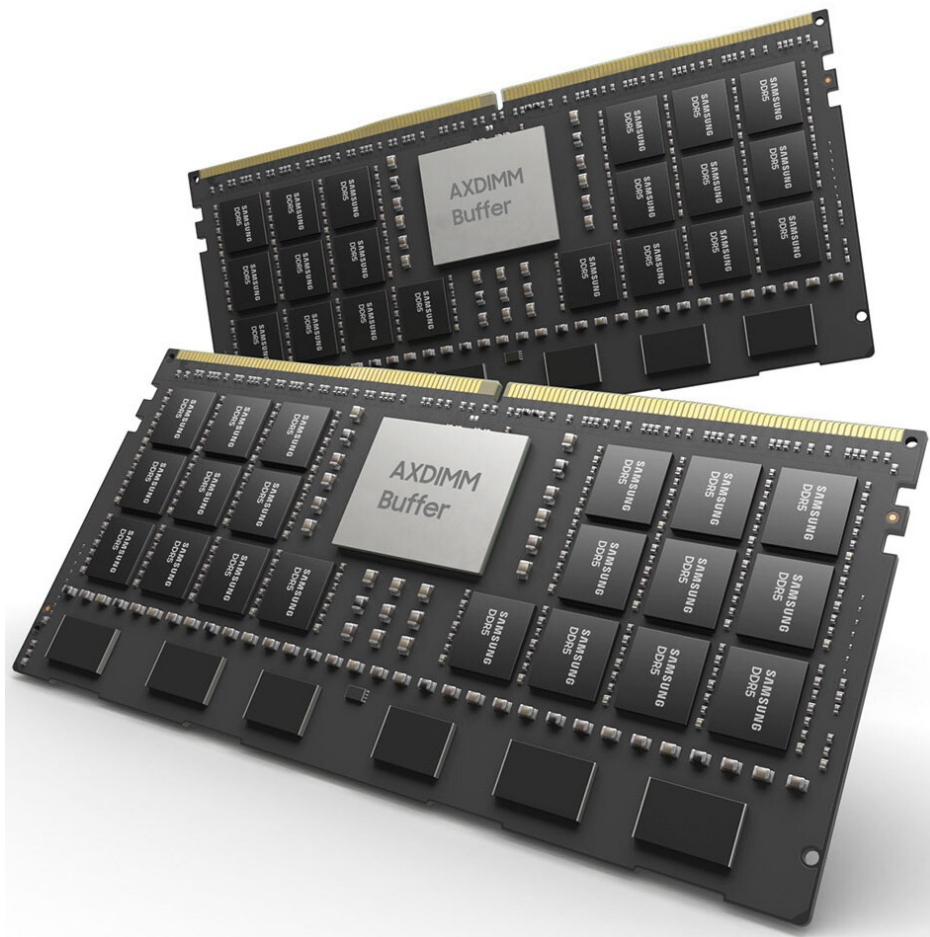

SK Hynix AiM: Chip Implementation (2022)

- 4 Gb AiM die with 16 processing units (PUs)

AiM Die Photograph

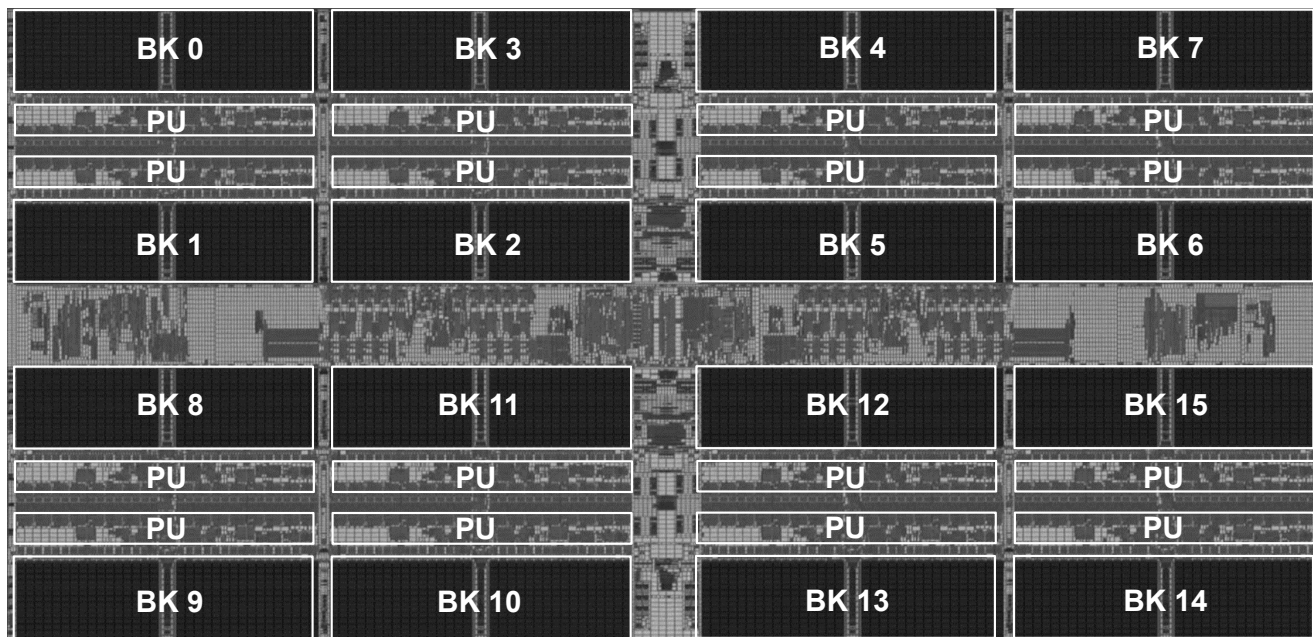

1 Process Unit (PU) Area

| | |
|--------------------------|---------------------|
| Total | 0.19mm ² |
| MAC | 0.11mm ² |
| Activation Function (AF) | 0.02mm ² |
| Reservoir Cap. | 0.05mm ² |
| Etc. | 0.01mm ² |

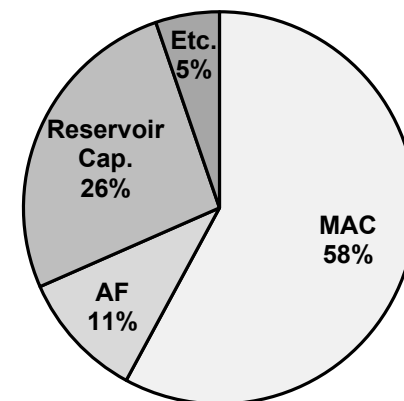

SK Hynix AiM: System Organization (2022)

■ GDDR6-based AiM architecture

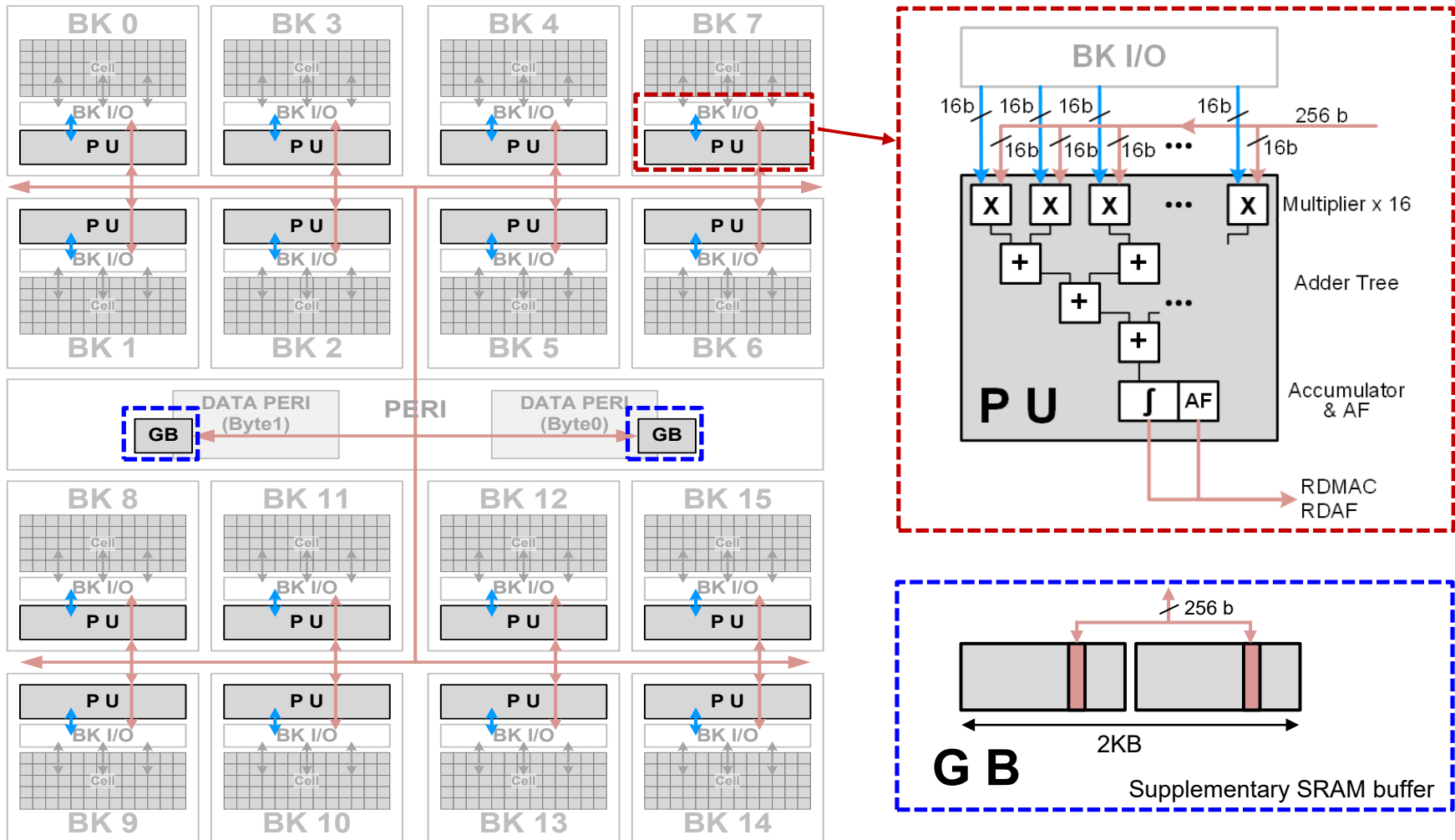

AliBaba PIM Recommendation System (2022)

ISSCC 2022 / February 24, 2022 / 8:30 AM

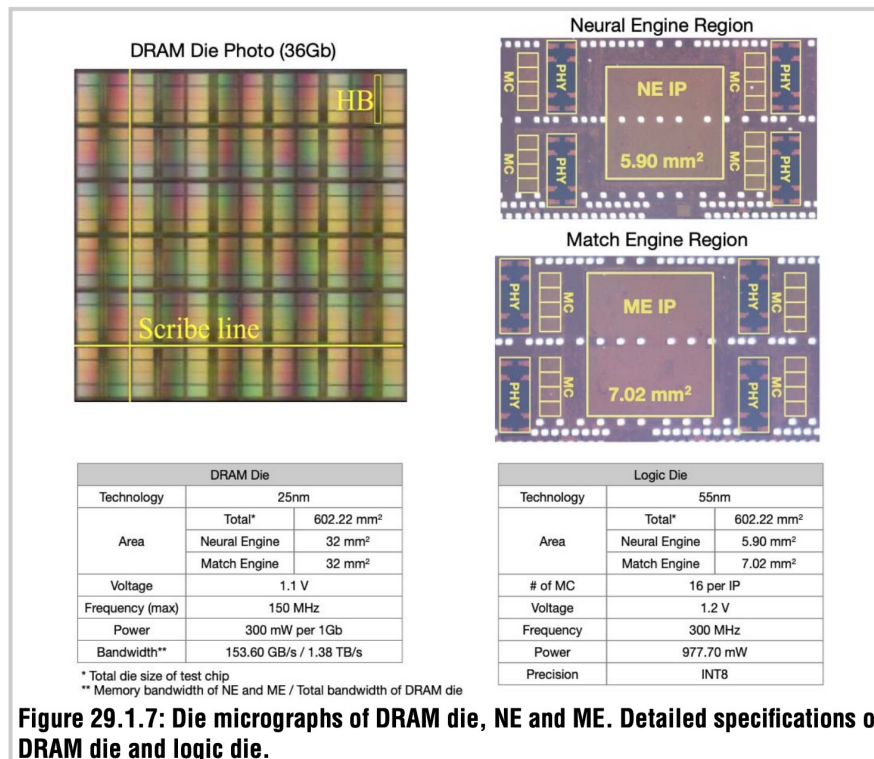
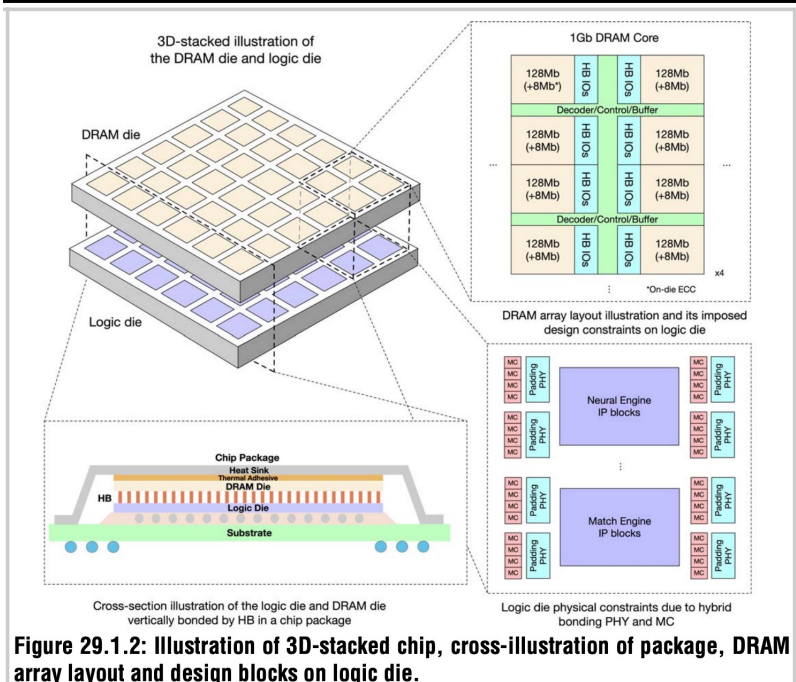

29.1 184QPS/W 64Mb/mm² 3D Logic-to-DRAM Hybrid Bonding with Process-Near-Memory Engine for Recommendation System

Dimin Niu¹, Shuangchen Li¹, Yuhao Wang¹, Wei Han¹, Zhe Zhang², Yijin Guan², Tianchan Guan³, Fei Sun¹, Fei Xue¹, Lide Duan¹, Yuanwei Fang¹, Hongzhong Zheng¹, Xiping Jiang⁴, Song Wang⁴, Fengguo Zuo⁴, Yubing Wang⁴, Bing Yu⁴, Qiwei Ren⁴, Yuan Xie¹

Tutorial on Memory-Centric Computing: Processing-Near-Memory

Dr. Mohammad Sadr
Prof. Onur Mutlu

ISCA 2024
29 June 2024